

Fire protection.

Box, housing and sealing systems for fire-protection walls and ceilings.





For safe functions, rooms and escape routes.

Fire protection engineering.

When it comes to structural fire protection, building technology planners and installers face particular challenges. Experience shows that a fire can start anytime, anywhere. Even strict fire regulations offer no guarantee in this respect. The greatest potential danger is not the building itself, but the technical and electrical systems.

For 90% of fire victims and around 70% of property damage, it was not the fire itself but dangerous, toxic smoke that was the decisive factor. In addition to preventing and fighting fire, it is therefore essential to prevent the formation and spread of smoke.

The most important goals of preventive fire protection are to save human lives and minimise damage to property. To this end, functional integrity of fire protection equipment, usability of escape routes and access for rescue services must be guaranteed.

KAISER fire protection systems have been providing you with reliable solutions for electrical installations in fire protection walls and ceilings for over 10 years, ensuring required fire resistance classes, even in the event of fire. Intelligent products for active, preventive fire protection made of fire-resistant, halogen-free materials that meet current legal and technical requirements. Products for walls and ceilings in buildings and for shipbuilding walls. Products that can save lives and prevent disasters with their reliability.





Legal requirements Fire Protection Engineering.	4
Building material classes and fire resistance classes. DIN 4102.	6
Walls and ceilings. DIN 4102.	7
Keeps the way clear in an emergency. Kaiser AFS technology.	8
KAISER has Europe-wide approvals for fire barriers.	9
KAISER installation. Simple and safe.	9
Safety and fire protection in electrical installations. Fire resistant and halogen free.	9

Requirements

Product solutions



Installation in walls

Professional and standardised
 For fire protection walls up to **E1120** or **F60-B**,
 installation shafts and ducts.
 Safe in cavity walls.

Flush-mounting fire-protection box.	10
HWD 90 fire-protection boxes.	12
HWD 68 fire-protection box.	16



Installation for walls. Implementation and onboarding

Penetrations and entries in cavity walls, masonry and concrete.
 Safe implementation and onboarding. Even as a retrofit.
 Installation also in concrete and masonry.
 Bundles inserted throughout every wall. Safe and available as a retrofit.
 Installation also in concrete and masonry.
 Easy closure. Permanently sealed.

Fire sealings.	18
LS 90 cable sealing systems. RS 90 conduit sealing systems.	19
LS 90 / RS 90 cable and conduit sealing systems.	19
DS 90 and DS 90 / 74 mm box sealing system.	20
DS 90 and DS 90 / 120 mm box sealing system.	21
Sealing plugs.	22



Installation in ceilings

For EI 30-EI 90 fire protection walls.
 For lights and loudspeakers.
 Sealings in fire-protection ceilings.
 Protection against latent fire hazards.
 Air-tight installation and fire-preventive protection.

HWD 30 fire-protection boxes.	24
FlamoX® fire-protection housing.	26
DS 90/74 and DS 90/120 mm ceiling penetration sealing system.	28
ThermoX® installation housing.	32
ThermoX® LED installation housing.	34



Installation in ship walls

Fire- and smoke-proof walls in ship cabins.
 For cabin walls in shipbuilding.

Fire protection technology in shipbuilding.	36
HWD B15 fire-protection boxes.	36

Fire protection engineering. At a glance.	38
KAISER PRODUCT RANGE.	40



You can find corresponding product videos at www.youtube.de/kaiserelektro.



Legal requirements. Fire protection engineering.

Building law in Germany falls under the jurisdiction of the federal states due to federalism. As part of a joint working group (ARGEBAU), the state ministries responsible for construction develop draft model laws, which can then be implemented as laws, ordinances or guidelines that are valid in the individual state with varying degrees of modification, depending on the respective federal state. Section 14* of the Model Building Code (MBO) defines the basis for fire protection:

The requirements of the regional building law (BauO) and state building regulations (LBO) are supplemented by various decrees, implementing regulations, technical building regulations and building authority standards. In addition, defective fire protection is considered to be a deliberately concealed defect with a 30-year liability period. Planners and contractors even have a duty of care over the entire service life of a building. In the event of personal injury (death), Section 319 (construction hazard) of the German Penal Code (StGB) takes effect and threatens those responsible with large fines or even imprisonment.

* Section 14 MBO Fire protection Nov. 2002

Structures shall be arranged, erected, altered and maintained in such a way that the development of fire and the spread of fire and smoke (fire spread) is prevented and, in the event of fire, the rescue of people and animals as well as effective extinguishing work are possible.

The state building codes (LBO) differentiate buildings into:

- • Buildings of normal type or use (residential buildings and buildings of comparable use)
- • Buildings of a special type or use (industrial buildings, places of assembly or hospitals, etc.)

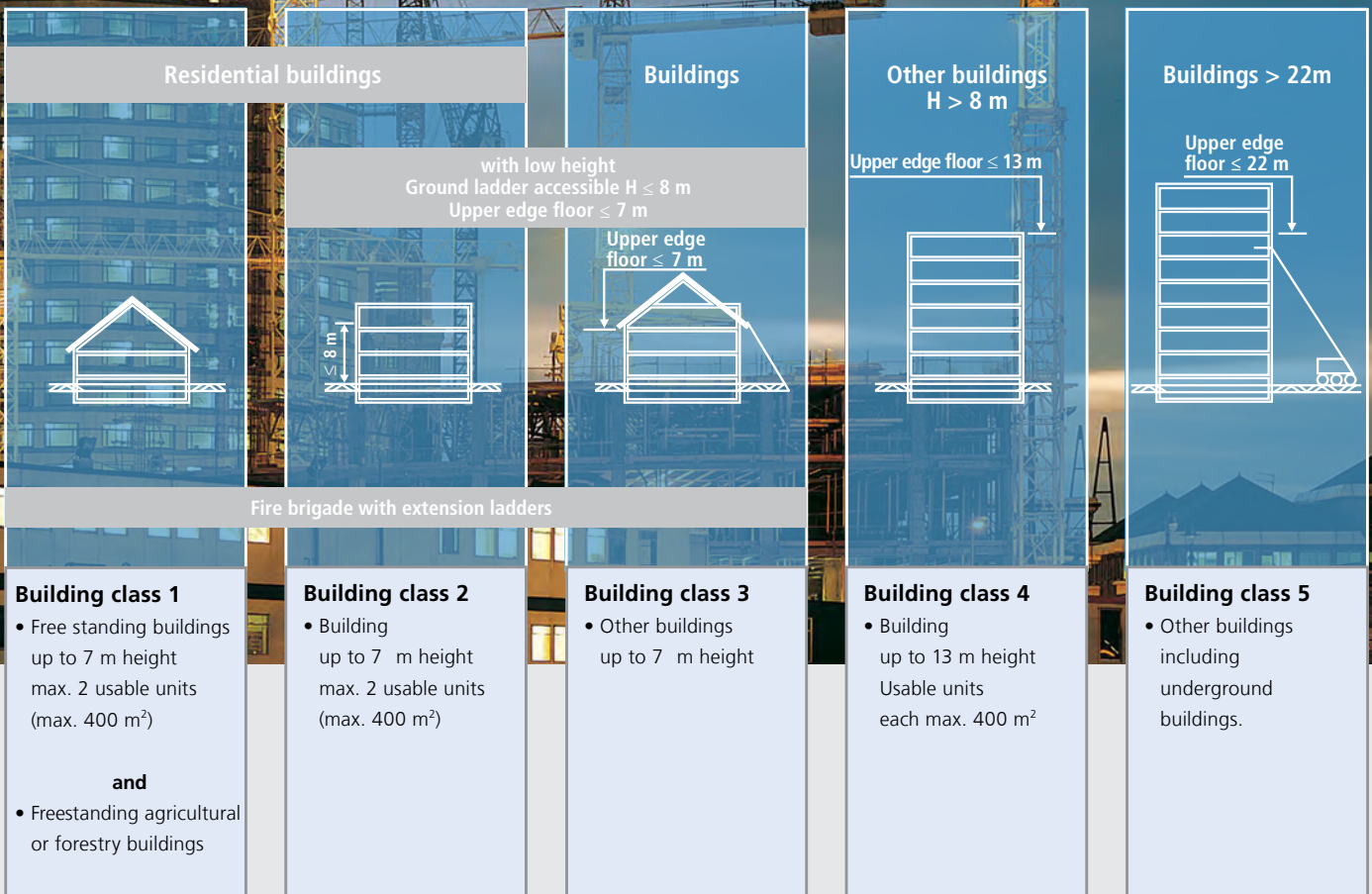

DIN 4102 defines the requirements of the wall and ceiling properties for the fire resistance classes. The prescribed fire resistance class depends on the building use and the building class (see table below).

For **"buildings of a special type or use"**, supplementary ordinances apply, such as the Ordinance on Places of Assembly (MVStättV), the Ordinance on Sales Premises (MvkVO), the Hospital Construction Ordinance (KhBauVO), the School Construction Directive (MschulbauR) or the Industrial Construction Directive (MidBauRL).

The regional building law (BauO) regulates the conditions that must be observed for every building project. The requirements relate to the property as well as its development. Requirements include:

- Observance of distances
- Statics
- Provisions for escape routes
- Protection against moisture
- Fire protection and thermal insulation

Fire protection requirements according to the MBO

Assignment of fire protection and fire resistance classes in building construction

Component	Section of the MBO	Building class				
		1	2	3	4	5
		h ≤ 7 m			h ≤ 13 m	h ≤ 22 m
Load-bearing walls, columns	Section 27	EI0	EI30	EI30	EI60	EI90
Load-bearing walls, columns in the basement floor		EI30	EI30	EI90	EI90	EI90
Load-bearing walls, supports in the top floor if there are living rooms above it		EI0	EI30	EI30	EI60	EI90
Non-load bearing exterior walls	Section 28	none			A or EI30	A or EI30
Partition walls	Section 29	EI0	EI30 ²⁾	EI30	EI60	EI90
Ceilings	Section 31	EI0	EI30	EI30	EI60	EI90
Ceilings in the top floor, if there are spaces for interior use above them		EI0	EI30	EI30	EI60	EI90
Basement ceilings		EI30	EI30	EI90	EI90	EI90

1) The height refers to the upper edge of the floor of the uppermost storey above ground level 2) Does not apply to residential buildings
In special buildings (e.g. under the high-rise building directive) or fire and composite walls (VdS 2234), the fire resistance class can be up to EI180.



A1 non-combustible building materials without organic components

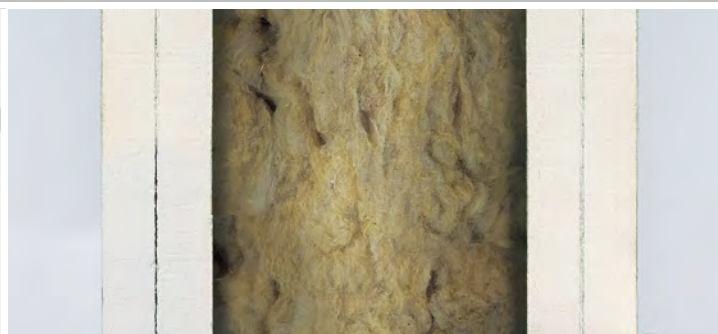

A2 non-combustible building materials with organic components



B1 combustible building materials flame resistant



B2 combustible building materials normal flammability

Building material classes and fire resistance classes.

DIN 4102.

The fire behaviour of building materials for walls or ceilings is influenced by the type, shape, surface, mass, material joints and processing technique. Building materials are classified according to fire classes **A** or **B**:

The fire resistance duration is the minimum duration in minutes during which a building component may not exceed a temperature increase of 140 K on average (max. 180 K at certain points) on the side facing away from the fire (according to DIN 4102-2).

Building material class A - non-combustible building materials
A1 - without organic components
A2 - with organic components

The fire resistance duration is divided into the following classes
EI0/30 Fire retardant
EI60 Highly fire retardant
EI90/120/180 Fire resistant / highly fire resistant

Building material class B - combustible building materials
B1 - flame retardant building materials
B2 - normally flammable building materials
B3 - highly flammable building materials

Examples for fire resistance classes:

Walls, ceilings, columns	EI30/60/...
Fire walls	EI90/120/...
FS closures (doors, etc.)	T30/60/...
Cable sealings	S30/60/90/...
Installation ducts	I30/60/90/...
Conduit entries	R30/60/90/...
Function maintenance	
Electr. cables	E 30/60/90/...

Examples for naming:

EI30-A	Fire-retardant / non-combustible building materials
EI30-B	Fire retardant / combustible building materials
EI90-A	Fire-resistant / non-combustible building materials
EI30-AB	Fire retardant / non-combustible and combustible building materials

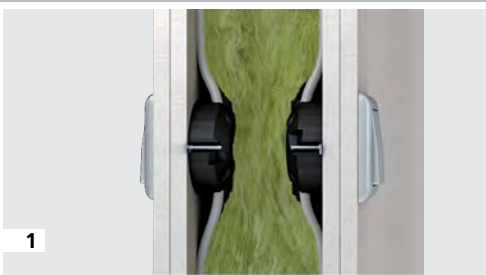

1

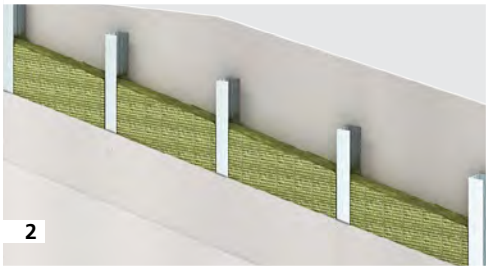

2



3

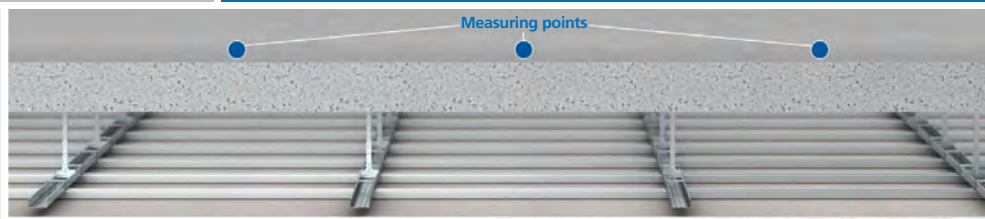

4

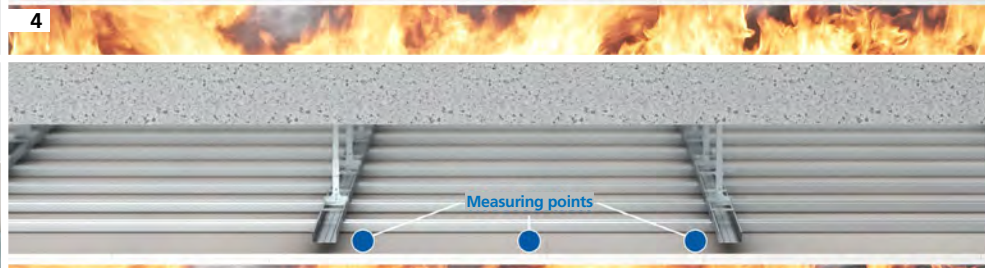

5



6

- 1 + 2 Installation of EI90 metal stud walling in compliance with DIN 4102, Part 4.
- 3 Structure of an EI90 solid wall.
- 4 Suspended ceilings under raw ceilings according to DIN 4102-4 of construction type I, II, III. Ceiling constructions consisting of raw ceilings and suspended ceilings provide the required fire resistance.
- 5 **Self-contained suspended ceilings.** Independent suspended ceilings provide the required fire resistance independently of raw ceilings.
- 6 Fire load from the ceiling cavity.

Walls and ceilings. DIN 4102.

Fire protection walls or ceilings must not contain any openings. However, if it is necessary for the use of the building, closures for windows, ducts or installations must be carried out with a fire resistance of at least 30 to 90 minutes (e.g. EI30-EI90). Incorrectly designed openings would significantly weaken the fire compartment separation.

Fire protection walls of fire resistance class EI30-F180 according to DIN 4102-4 are 1- or 2-shell, non-load-bearing, internal partition walls with wall thicknesses from 100 mm, insulation material according to DIN 4102-17 and 2 x 12.5 mm plasterboard. According to DIN 4102, installation of opposing cavity wall sockets is not permitted and installation of individual boxes is only permissible with restrictions. This means that on-site cladding is required, e.g. with plaster, fibre silicate or similar.

KAISER fire protection boxes and housings fully meet these requirements.

Fire protection ceilings according to DIN 4102 are either independent ceiling constructions or suspended ceilings connected to ceilings of construction type I, II, or III (concrete ceilings, brick ceilings). From fire resistance class EI30, DIN 4102 stipulates a closed visible surface. Openings, e.g. for lights, are to be appropriately sealed.

FlamoX® fire protection housings from KAISER (see page 26) have been specially developed for F30 ceilings.

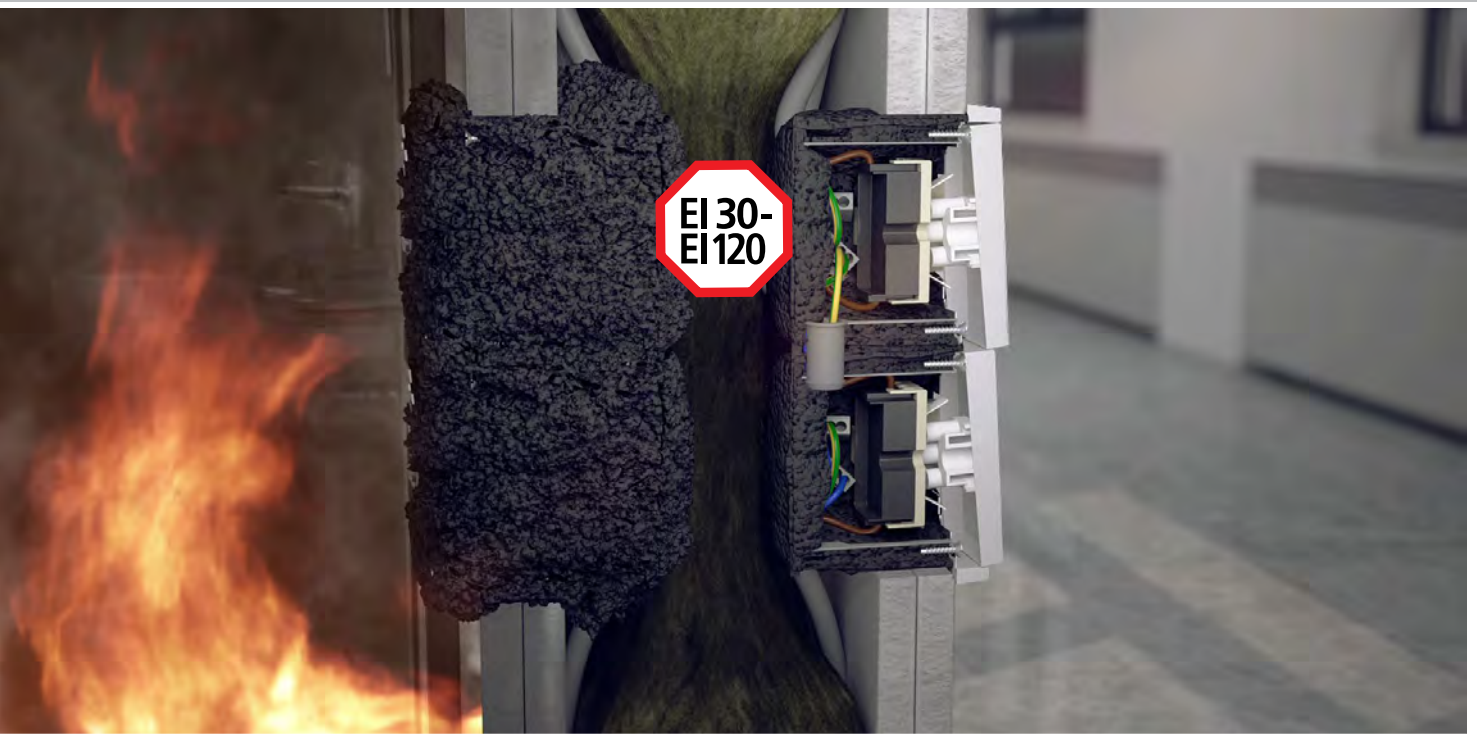

Keeps the way clear in an emergency. **KAISER AFS TECHNOLOGY.**

AFS - Active Fire Stop - guarantees preventive fire protection. Whether the fire load comes from above, below, from the front or the back: the quick-active, fire-retardant coating in boxes, housings and bulkheads reacts immediately in the event of fire and safely fills the installation opening with foam. The fire resistance class for the wall of EI30 - EI120 or for the ceiling of EI30 - EI90 remains unchanged. Transmission of fire and smoke is thus safely prevented.

The high standard and reliability of AFS technology ensure that people's lives are saved and disasters are prevented - both in buildings and on ships. In cavity walls, flush-mounted and ceiling boxes, in installation housings and in sealings, this intelligent technology is already the KAISER standard.

In the event of fire, KAISER AFS technology maintains the fire protection class in walls and ceilings, even when installed opposite each other without any casings. Ready-to-install systems with AFS technology guarantee certified safety and smooth installation.



The effect of heat causes fire-retardant coating to foam, which prevents fire and smoke from spreading.

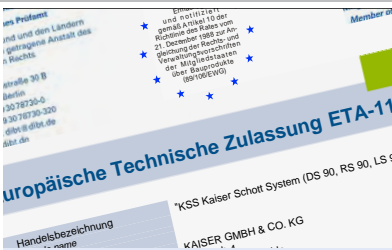

KAISER Fire Barrier Systems - Europe-wide certified quality!

The innovative fire sealings from KAISER stand for Europe-wide certified quality that you can rely on! All KAISER fire protection systems are ideally suited for professional electrical installations in fire protection walls and in concrete or cellular concrete ceilings. Box and ceiling penetration seals from KAISER for both cables and conduits comply with fire resistance classes and

do not release any hazardous substances. This means that KAISER fire sealings allow fast, professional and - in every respect - safe sealing for fire protection engineering.

All certificates can be found in the download area at www.kaiser-elektro.de

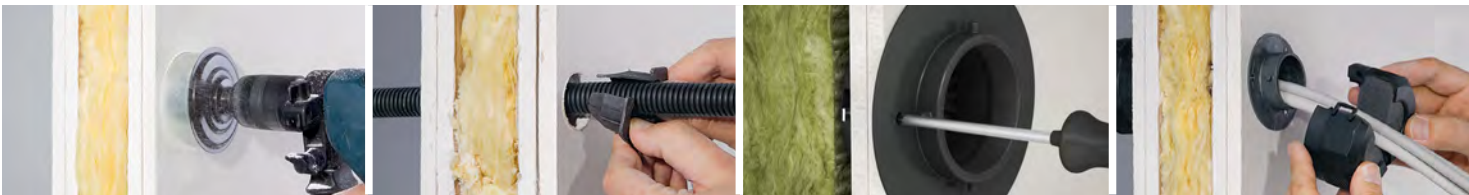

KAISER - The basis for good installation. Simple, safe and clean.

KAISER fire protection products can be installed easily, safely and cleanly. Because the fire protection products can be installed with standard tools - no greasing or filling is required - your installation requires minimal labour - and no training!

At www.kaiser-elektro.de and on our YouTube channel www.youtube.de/kaiserelektro you will find informative product demonstrations for assembly and operation.



Glow wire resistant and halogen-free.

halogen-free

The glow-wire resistance of cavity wall boxes and casings is tested using a glow wire test, i.e. without an open flame, at 850 °C. This test must demonstrate that a fire cannot start in the cavity wall boxes if a fault occurs in the electrical installation. In addition, always ensure compliance with the current fire prevention measures for wall constructions.

For cavity wall boxes with the VDE test mark, glow wire resistance is tested and confirmed according to VDE 0471/EN 60695-T. 2-10.

Halogen-free cavity wall sockets

In addition to halogen-free fire protection products, all KAISER boxes and casings for cavity wall mounting as well as several accessory parts are available as halogen-free products. These products are available in white to identify them as such.



Professional and standardised. Flush-mounting fire-protection box.

sound
insulation
value $R_{w,125}$
56 dB

The **innovative fire protection box** for flush-mounted installation in solidly built fire protection walls maintains the fire resistance duration of the fire protection wall from F30-F120 (EI30-EI120) despite the electrical installation embedded in it.

The **flush-mounted fire protection box** ensures a safe, smokeproof closure of the fire protection wall, even if the opposing or single-sided installation falls below the **residual wall thickness of 60 mm required by DIN 4102-4**. This is made possible by AFS technology. This is a sheathing fire-retardant coating that foams up within a very short time in the event of a fire. In this way, it automatically closes the installation openings and maintains the wall's fire resistance. The spread of smoke and fire through the installation openings is thus reliably prevented.

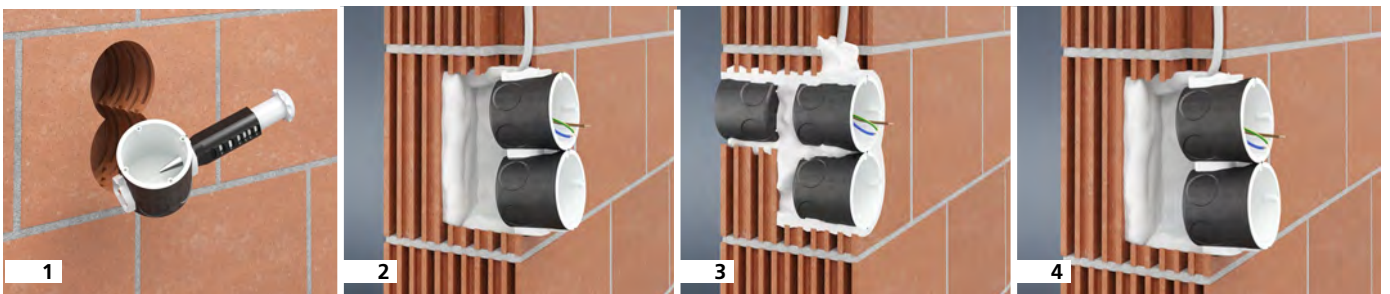

- 1 Make exact cable and conduit entries with the universal opening cutter (Art. No. 1085-80).
- 2 Fixing is simply carried out with plaster or mortar. Special fire-protection mortar is not necessary.
- 3 For one-sided (minimum remaining wall thicknesses ≤ 60 mm) and for direct installation to the opposing side.
- 4 For F30-F120 (EI30-EI120) fire-protection walls.

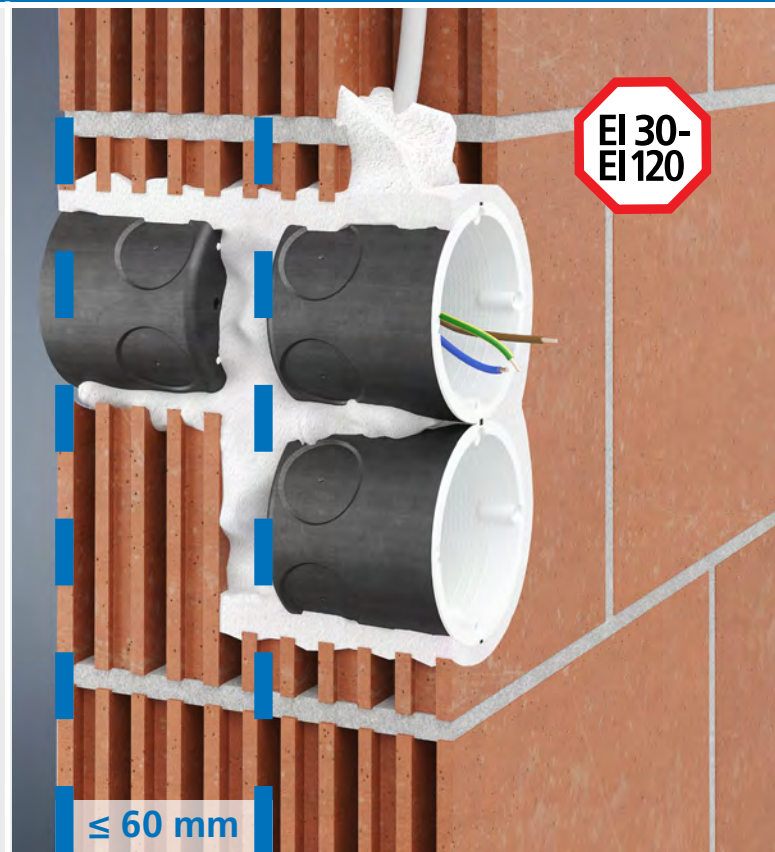

- For EI30-EI120 fire-protection walls
- For minimum remaining wall thicknesses ≤ 60 mm
- Also for direct installation to the opposing side
- Installation up to 5-unit combinations
- Variable combination connection piece for conduits up to M25
- With a fire-protection cover, it can be used as a junction box

KAISER's new flush-mounting fire-protection boxes are the first of their kind to prevent the spread of fire and smoke through installation openings in solid fire-protection walls. Effective fire-protection is provided even when the remaining wall thickness is less than 60 mm.



Minimum remaining wall thickness ≤ 60 mm

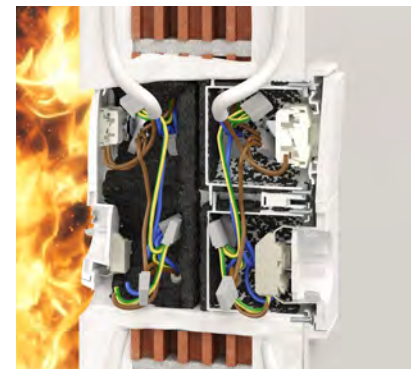

The AFS technology ensures that fire protection is maintained.

ETA-18/0091
ETA-18/0091 vom 13. April 2018

ETA
ETA-18/0091

Type approval
Z-19.21-2413

EI30 - EI120

Flush-mounting fire-protection box
Art. No. 1564-01

Fire-protection cover
Art. No. 1184-94

Suitable tools, such as the universal opening cutter (Art. No. 1085-80) and diamond grinding crown (Art. No. 1088-02) can be found on page 38



For fire-protection walls up to EI120. HWD 90 fire-protection boxes.

Since the first fire-protection box for fire-protection walls was launched in 2006, its range of applications has been continually expanded. The further development of AFS technology has resulted in fire protection boxes now withstanding a fire resistance duration of up to 120 min. In addition, the German Institute for Building Technology (DIBt) has now extended the approval of the fire protection boxes to wooden walls in timber frame and timber panel construction to F60-B.

The usual simple assembly has not changed. Even directly opposite installation up to a 5-unit combination maintains a fire resistance class of up to EI 120 (max. 3-unit combination with F60-B). All type HWD 90 boxes completely maintain sound insulation protection up to a sound insulation value of 77 dB.



- For EI30-EI120, F30-B/F60-B fire-protection walls
- Maintains the wall's sound insulation function
- Also suitable for retrofitting
- With a fire-protection cover, it can be used as a junction box
- Also for direct installation to the opposing side

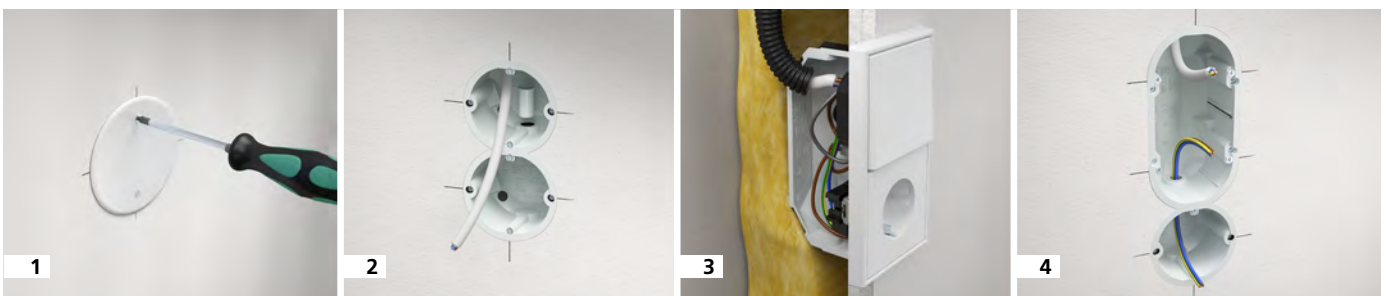

- 1 With a fire-protection cover, it can be used as a junction box
- 2 The fully-insulated through-wiring of one-gang junction boxes with each other is created using the support connector (Art. No. 9060-78).
- 3 The electronic socket creates sufficient space for the cable reserve when communications and network boxes are installed.
- 4 Electronic sockets can be combined with each other or with the one-gang junction box.

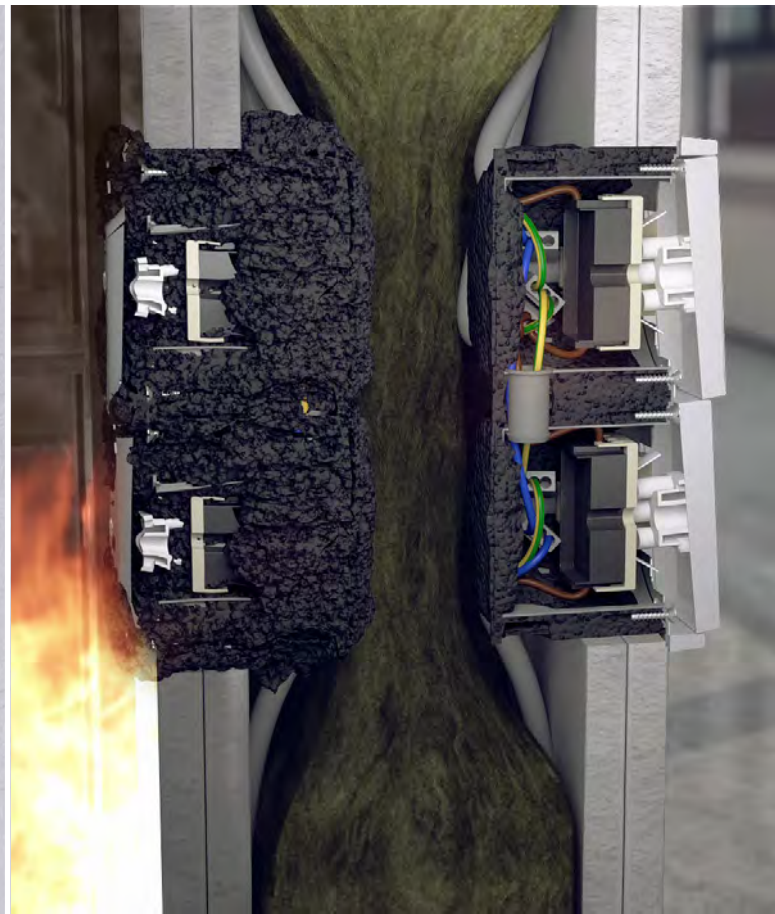

The HWD 90 electronics box has the necessary installation space for electronic switch devices, communication outlets, cables and terminals. It enables fitting with cables and also with installation conduits up to M25.

- Also for use as a double box
- Extra-large terminal compartment for communications and network technology
- Additional space for electronic components (KNX actuators, relays, radio modules, communications technology)

- For EI30-EI120, F30-B/F60-B fire-protection walls
- Maintains the wall's sound insulation function
- Also suitable for retrofitting
- With a fire-protection cover, it can be used as a junction box
- Also for direct installation to the opposing side

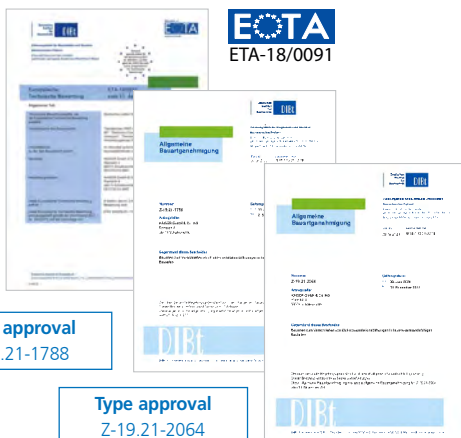

Plasterboard drywall

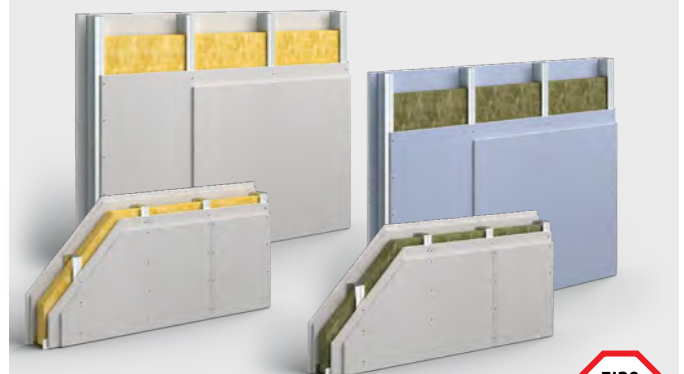

- Minimum wall thickness: 100 mm
- Boarding on both sides with
 - min. 12.5 mm mineral non-combustible building panels (e.g. plasterboard, cement-bonded fibre boards)
 - min. 40 mm thick non-combustible mineral wool (e.g. glass wool, rock wool, etc)
- Bulk density min. 40 kg/m³



The matching Ø 74 mm cutter (Art. No. 1084-10) can be found on page 38.



- 1-2 HWD 90 electronics box: additional space for electronic components (KNX actuators, relays, radio modules, communications technology)
- 3 Direct Opposing installation possible.
- 4 Fully insulated through-wiring.
- 5 Installation shafts and ducts

EI30 - EI120, F30-B, F60-B

HWD 90 one-gang box
Art. No. 9463-01

HWD 90 one-gang junction box
Art. No. 9464-01



Ø 74 mm



Ø 74 mm

HWD 90 electronics box
Art. No. 9462-94



2 x Ø 74 mm

Fire-protection cover
Art. No. 1184-94



Support connector
Art. No. 9060-78



Installation shafts and ducts



- Steel stand
- Double-sided boarding with non-combustible mineral gypsum or cement-bonded building panel
 - 20 mm (when using the one-gang box)
 - 25 mm (when using the one-gang junction box)
- I30 - no insulation
- I60 - 40 mm / 100 kg/m³, 60 mm / 50 kg/m³, 80 mm / 30 kg/m³
- I90 - 40 mm / 100 kg/m³ Termarock 100

The use of the HWD 90 in shaft walls is only approved in Germany by the general type approval. If the device is to be used in other countries, the applicable certificates, standards, guidelines or regulations must be observed.

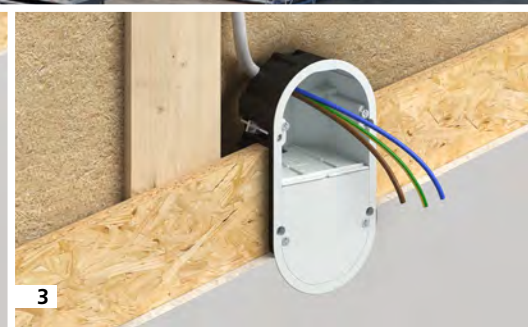
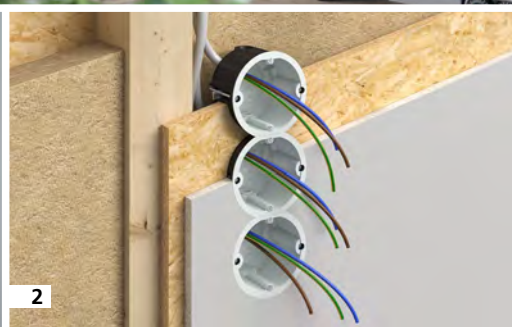

- 1 For F30-B and F60-B timber panel construction or timber frame construction walls with glass/rock wool or wood fibre insulation.
- 2 In an F60-B wall, combinations of up to 3 units each are possible. With an F30-B wall, combinations up to 5 units are possible.
- 3 The HWD 90 electronics box is also approved for the above mentioned wall constructions.

Drywall in timber construction

NEW

- For timber frame or timber panel construction walls
- Also for wall systems with wood fibre insulation
- Minimum wall thickness: 109 mm
- Panelling on both sides



Product video

Information material "HWD 90 fire protection boxes for timber panel and timber frame construction"

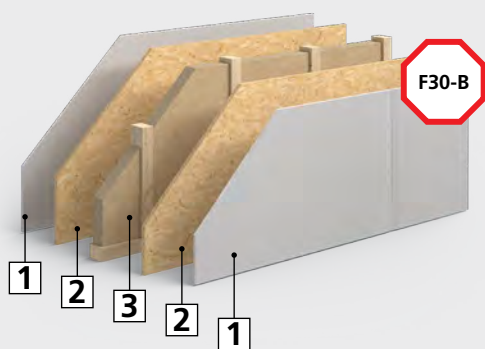
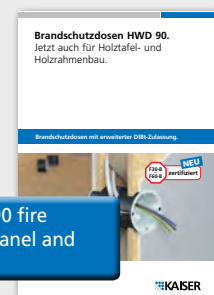

- 1 9.5 mm GKB plasterboard
- 2 15 mm OSB/MDF, plywood or chipboard
- 3 40 mm wood fibre insulation, glass or rock wool
- 60x40 wooden beams

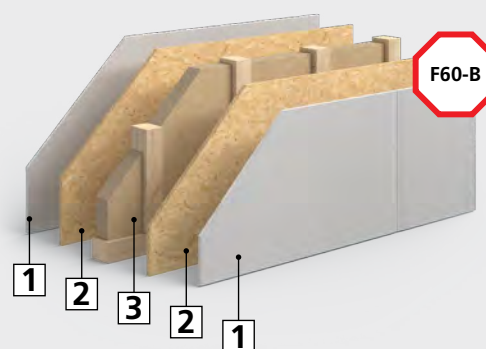

- 1 12.5 mm GFK plasterboard fire protection board
- 2 15 mm OSB/MDF, plywood or chipboard
- 3 60 mm wood fibre insulation, glass or rock wool
- 40x80 wooden beams



Centring insert 68/74: For the extension of existing installation openings from Ø 68 mm to Ø 74 mm exact guidance for hollow wall cutter MULTI 4000.

The matching Ø 74 mm cutter can be found on page 38.



Safe in cavity walls. HWD 68 fire protection boxes.

Sound insulation value R'_{w} to 69 dB

HWD 68 fire protection boxes form the basis of good fire protection. They stand out for their quick and easy assembly. Both the device and the one-gang junction box are installed in a 68 mm routed cut opening and can be easily combined by means of support connectors. Particularly outstanding is the simple introduction of sheathed cables. Without opening tools, cables can be inserted into the designated insertion without tools.

HWD 68 fire protection boxes are equipped with AFS technology - a fire-retardant coating - which automatically closes the installation opening in the event of a fire, thus preventing fire and smoke from spreading.

- For EI30-EI90 fire-protection walls
- Retrofitting possible
- For \varnothing 68 mm component openings
- For direct installation to the opposing side
- Simple break-out cable entry
- With a fire-protection cover, it can be used as a junction box

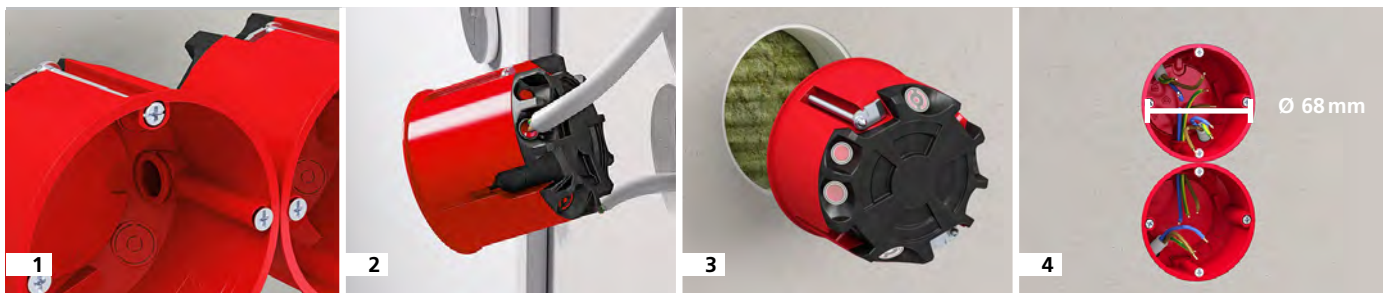

- 1 Fully-insulated through-wiring of one-gang boxes and one-gang junction boxes with the support connector (Art. No. 9060-68).
- 2 Break-out cable entry with cable retention acc. to DIN EN 60670.

- 3 Up to 6 options for cable entries for sheathed cables with external diameters of 4 - 11.5 mm.
- 4 The **HWD 68** is installed in a standard opening of \varnothing 68 mm.

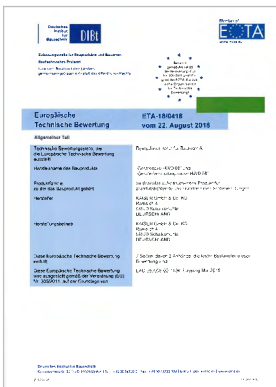
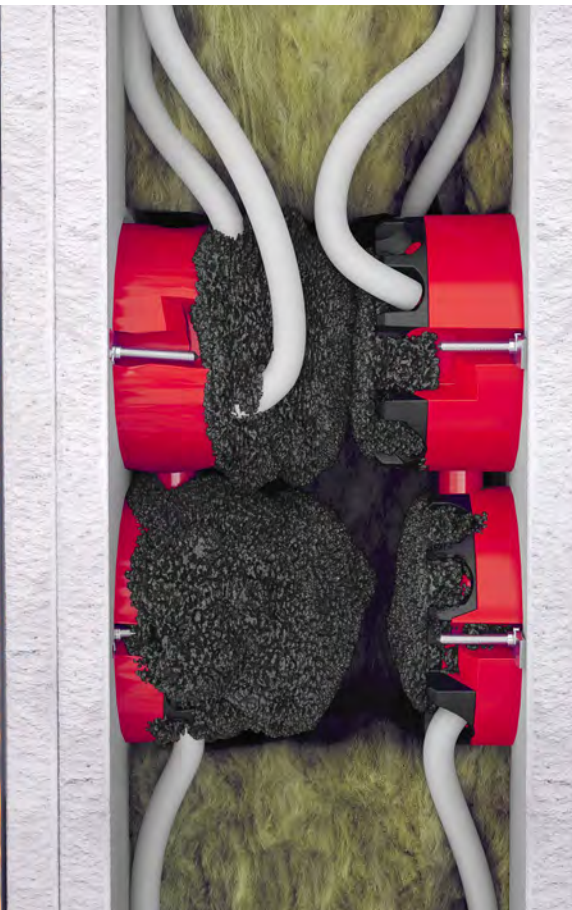

EOTA
ETA-18/0418

Type approval
Z-19.21-2321



The **HWD 68** is suitable for fire protection walls EI30 - EI90. The fire protection function is maintained even when boxes are installed directly opposite each other.

EI30 - EI90

HWD 68 one-gang box
Art. No. 9463-02



Ø 68 mm

One-gang junction box HWD 68
Art. No. 9464-02



Ø 68 mm

Support connector
Art. No. 9060-68



Fire-protection cover
Art. No. 1184-94



The matching cutter (Art. No. 1083-10) can be found on page 38.



Penetrations and entries in cavity walls, masonry and concrete.

Fire sealings.

Sealings in fire-protection walls are needed when cables or conduits must be fed through walls with a specific fire resistance class. To maintain the fire resistance class, the opening must be professionally sealed off to prevent fire or smoke from spreading.

KAISER solutions guarantee fast and, above all, absolutely safe and reliable partitioning in the event of fire. The time-consuming and messy processing of fire protection putty, foam, mortar or a fire protection coating is completely eliminated. Assembly is as simple as that of an KAISER cavity wall box.

- Secure, visible, certified fire sealing
- For wall feed-throughs and entries
- No filling or smoothing
- Independent sealing of joints and gussets
- Non-destructive retrofitting
- For cable bundles or individual installation conduits
- Also for mixed fitting of cable and conduit bundles

▶ **The LS 90 cable penetration seal and the RS 90 conduit penetration seal** can be easily installed in just a few steps. The installation opening is created using an appropriate cutter or drill and the flexible sealing is inserted. For retrospective installation, the sealing can be opened and slid over the existing cable or conduit. The cable and conduit sealings can be arranged as a group.

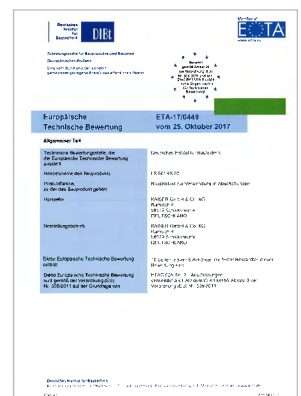

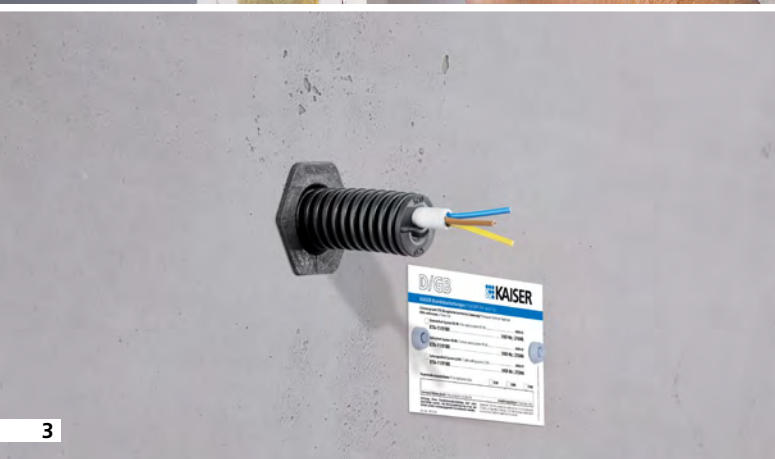

- 1 By unfolding the cable and conduit sealing, it can be easily placed around cables and conduits.
- 2 Passage through a solid masonry wall according to DIN 1053.
- 3 Wall penetration through a concrete wall according to DIN 1054.
- 4 For component openings smaller than \varnothing 35 mm, remove the lateral tear-off tab on the RS90.



▲ **The DS 90 / 74 mm and DS 90 / 120 mm box sealing systems** consist of two parts that are simply plugged onto each other and locked in place. The sealing cylinder, which closes the wall with AFS technology, is inserted into a \varnothing 74 mm or \varnothing 120 mm cut opening and fixed into place simply in the same way as a KAISER cavity wall box. Then the sealing element is placed around the cables, pushed onto the sealing cylinder and closed by means of a bayonet fitting by turning to the right with an audible click. This ensures a safe room closure. The sealing element can be opened for non-destructive reinsertion and additional cables can be fed through in no time. The box sealing can be closed again without additional sealing.

Maximum cable assignment!

DS 90 / 74 mm

- Cable bundle $\varnothing \leq 40$ mm (**full assignment**)
- Largest single cable in bundle $\varnothing \leq 15$ mm
- Largest single cable $\varnothing \leq 21$ mm
- Electrical installation conduits $\varnothing \leq 40$ mm

DS 90 / 120 mm

- Full assignment up to \varnothing 74 mm with cable and/or conduit bundle
- Largest cable diameter 29 mm
- Electrical installation conduits up to M63

▼ Both DS 90 / 74 mm and DS 90 / 120 mm box sealing systems enable safe, visible and certified fire protection sealing of cable and conduit entries in fire protection walls (EI30-EI90) in lightweight construction as well as in solid walls made of concrete and masonry. They enable sealing of individual cables and cable bundles as well as individual electrical installation conduits and conduit bundles. The two-part sealing cylinder and the hinged sealing element also allow installation on existing cables or conduits. By extending the sealing element with the cooling ribs, orderly bundling and thus optimal sealing for smokeproof room partitioning is achieved and ensured by the special foam inserts. The extra large sealing collar ensures smokeproof room partitioning even in the case of unclean openings. The installation of the box sealing systems in concrete and masonry walls is carried out without the use of special fire protection materials. Core drill holes of \varnothing 82 mm or \varnothing 150 mm and commercially available materials for fixing, such as plaster, mortar or quick-setting cement, are sufficient for installation.

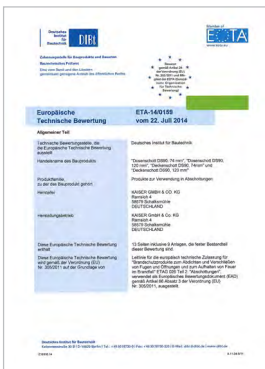
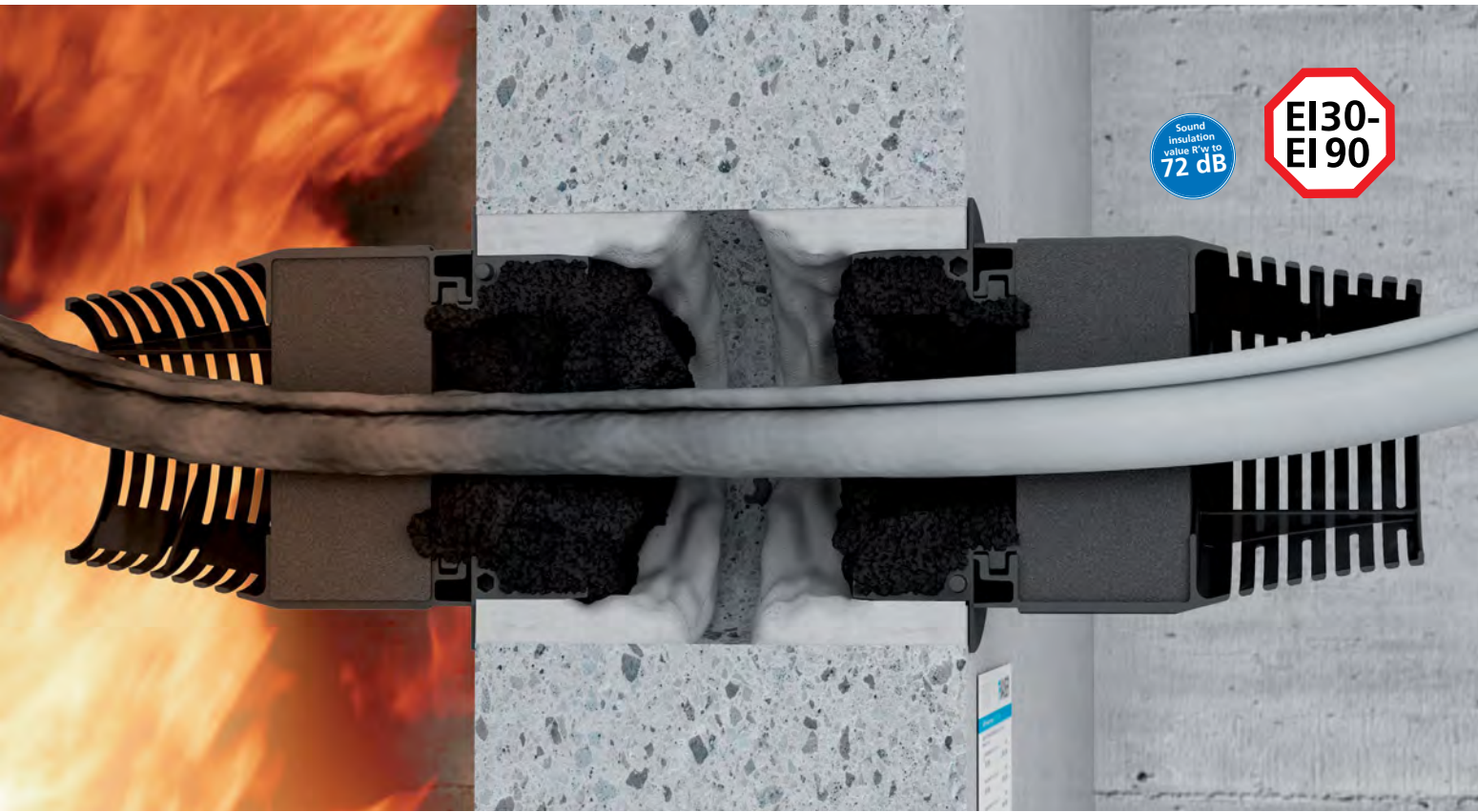

ETA
ETA-14/0159



The DIBt approval proves the reliable quality of the KAISER DS 90 / 74 mm and 120 mm box sealing systems.



LS 90
cable sealing system
Art. No. 9459-01



RS 90
conduit sealing system
Art. No. 9459-02



DS 90 / 74 mm
box sealing system
Art. No. 9459-03



DS 90 / 120 mm
box sealing system
Art. No. 9459-04



Suitable tools and identification plates can be found on page 38.

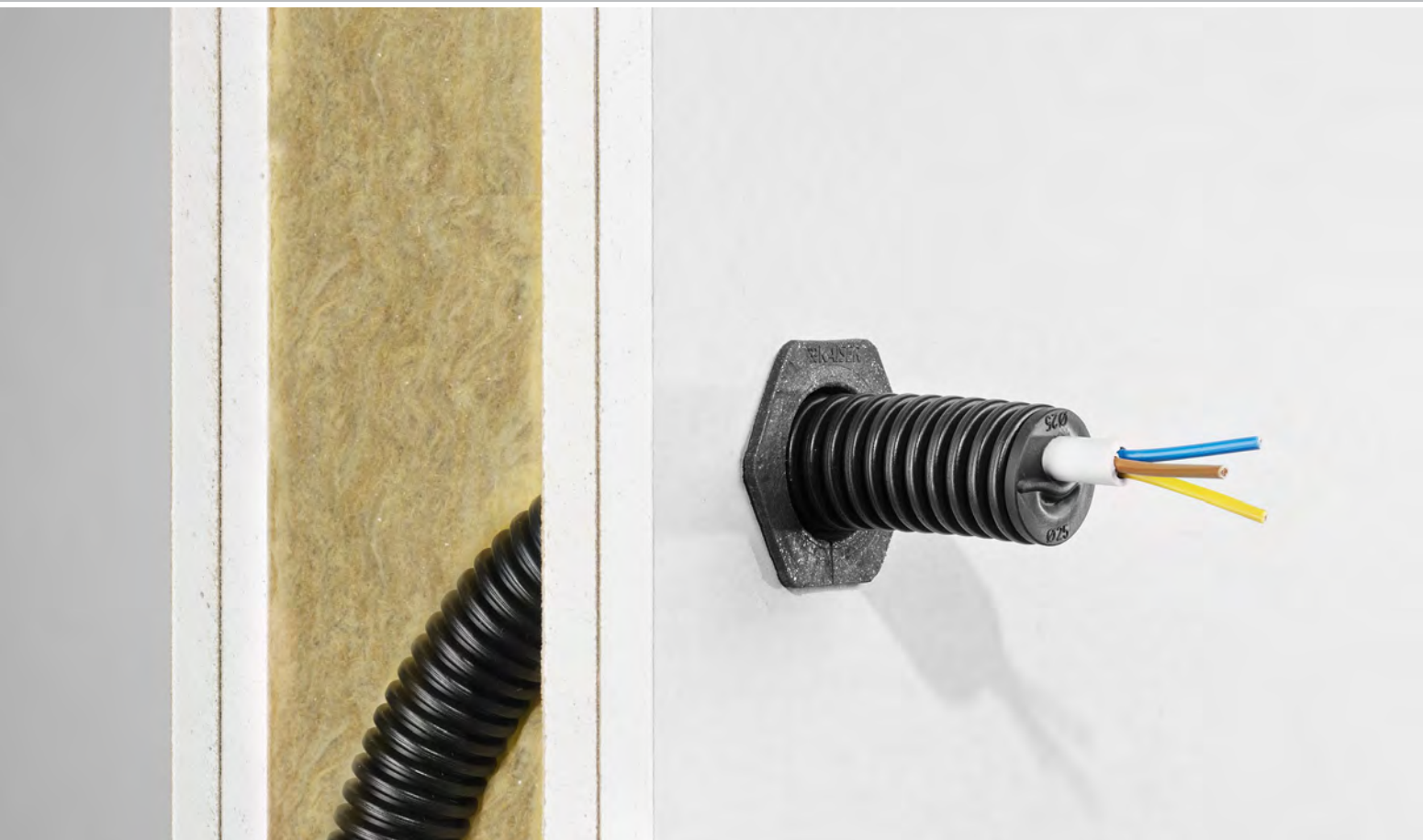

Easy closure. Permanently sealed. **Sealing plugs.**

Sealing plugs with ECON® technology, for sealing all common electrical installation conduits in one-gang boxes or at cable exits. The long sealing plug with three sealing lips and different widths adapts to the respective installation conduit and ensures an airtight, smokeproof closure even for conduits cut at an angle. From conduit size M25 upwards, the membrane areas are reinforced with ribs. These prevent damage and ensure air-tightness where the cables pass through.

- For empty conduit installations in an air-tight design or in fire protection areas
- Three sealing lips with different distances optimally adapt to the installation conduit
- Guaranteed airtightness
- Cable entry with no tools required
- Avoidance of tangled cables
- For all installation conduits M16 - M40, Pg 9 – Pg 36, 3/4" and 5/8"

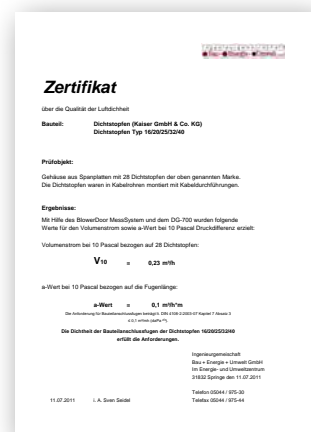

Air-tightness certificate

In comprehensive blower-door tests, a neutral institute tested and confirmed the air-tightness of the M16 - M40 sealing plugs.

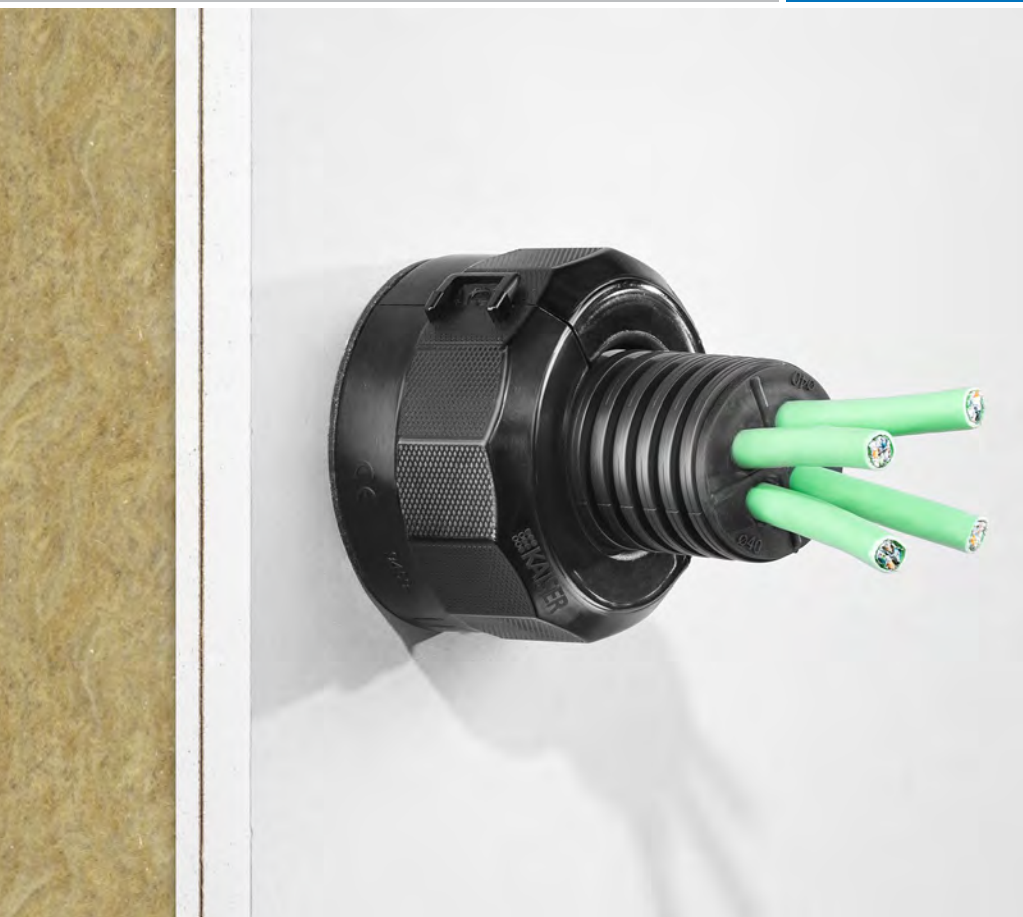

- 1 The long sealing plug with three sealing lips and different widths adapts itself perfectly to the installation conduit.
- 2 Even with diagonally shortened conduits, an airtight seal is created.
- 3 Separators in the membrane surface ensure safe cable routing.

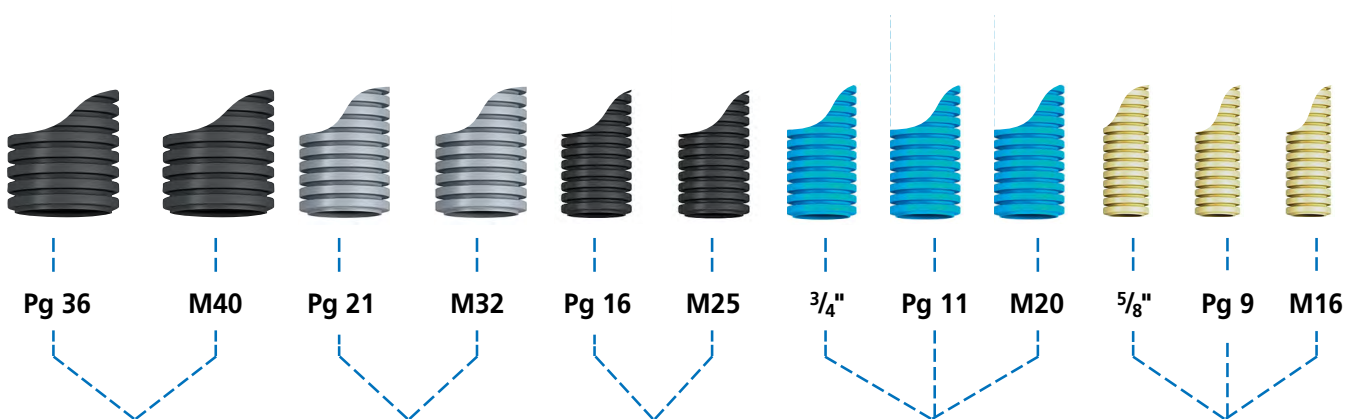

M40 sealing plug
Art. No. 1040-40



M32 sealing plug
Art. No. 1040-32



M25 sealing plug
Art. No. 1040-25



M20 sealing plug
Art. No. 1040-20



M16 sealing plug
Art. No. 1040-16





For EI30-EI90 fire-protection ceilings. **HWD 30 ceiling boxes.**

HWD30 installation boxes for fire-protection ceilings guarantee reliable fire protection of EI30 - EI90. In the event of a fire, the KAISER AFS technology's integrated fire-retardant coating immediately generates foam and seals the opening in the ceiling. The HWD30 ceiling box also provides protection when retrofitted.

- For EI30-EI90 fire-protection ceilings
- No encasing is required
- For installation of e.g. smoke detectors, lights, motion detectors, etc.
- With a fire-protection cover, it can also be used as a junction box
- Also suitable for retrofitting



Examples of use

The HWD 30 ceiling box can be used to install, for example, presence and smoke detectors or LED emergency route lighting in fire-protection ceilings without compromising the fire resistance class.

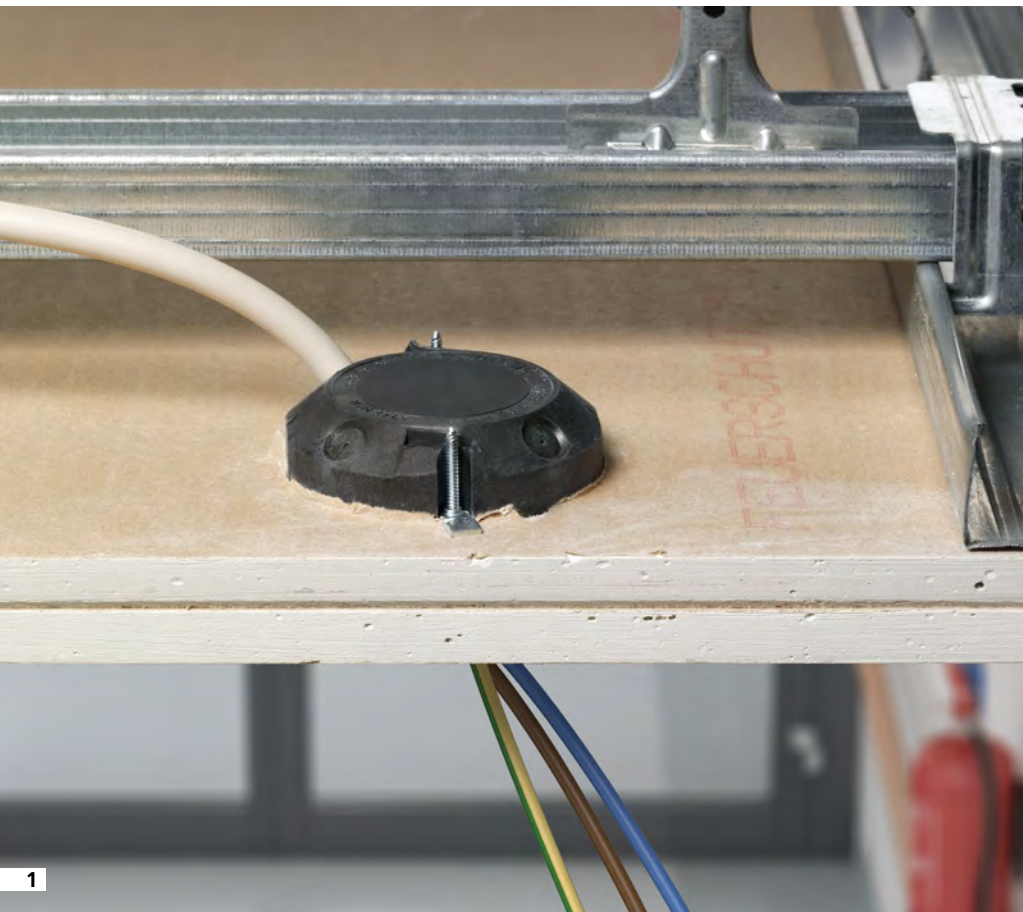

1 Installation of the HWD 30 ceiling box without mineral wool complies with fire resistance class EI30.

2 Installation of the HWD 30 ceiling box with mineral wool complies with fire resistance class EI60.

3 Installation of the HWD 30 ceiling box with Rockwool Termarock 100 complies with fire resistance class EI90.



EI30 - EI90

HWD 30 ceiling box
Art. No. 9463-50

Ø 74 mm



HWD 30 ceiling junction box
Art. No. 9464-50

Ø 74 mm



Fire-protection cover
Art. No. 1184-94



The matching Ø 74 mm cutter (Art. No. 1084-10) can be found on page 39.



For lights and loudspeakers. FlamoX® fire-protection housing.

The **FlamoX® fire-protection housings** form the new generation of the tried-and-tested housings for the installation of accessories, such as lights, loudspeakers or other devices in suspended fire-protection ceilings.

These new generation housings have been dimensioned to suit the needs of modern lighting systems, making them universally suitable for use. The housings can now also be used to install LED lights, lights with compact fluorescent lamps, low-voltage and high-voltage halogen lamps, loudspeakers and other devices, including any necessary operating devices. The housings can easily be installed in fire-protection ceilings from below through the installation opening made for them. Due to their low weight, even when lights or loudspeakers are fitted, the maximum permitted weight load of 5 kg/m² is not exceeded. As a result, no additional suspension devices are needed.

FlamoX® housings comply with fire-resistance class F30 (EI30) and withstand fire loads from above and below. This enables electrical installation companies to optimise the constructional fire protection effectiveness of fire protection ceilings.

With the "BAKA "Praxis Altbau award for product innovation", the German Federal Ministry of the Environment, Nature Conservation and Nuclear Safety, the BAKA Bundesverband

Altbaurenewerung e. V. (German association for the renovation of old buildings) and Messe München (Munich trade fair) honour pioneering product ideas and system solutions for applications in the field of existing buildings.



Functioning of the fire-retardant coating in the event of fire (fire load from below or above)



The effect of heat causes fire-retardant coating to foam, which prevents fire and smoke from spreading.

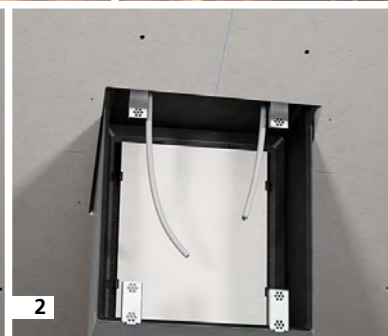
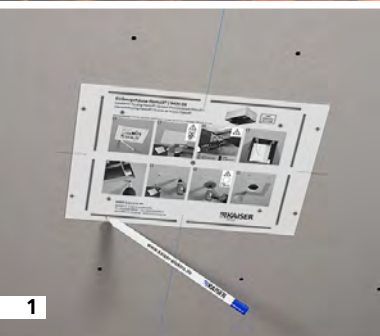
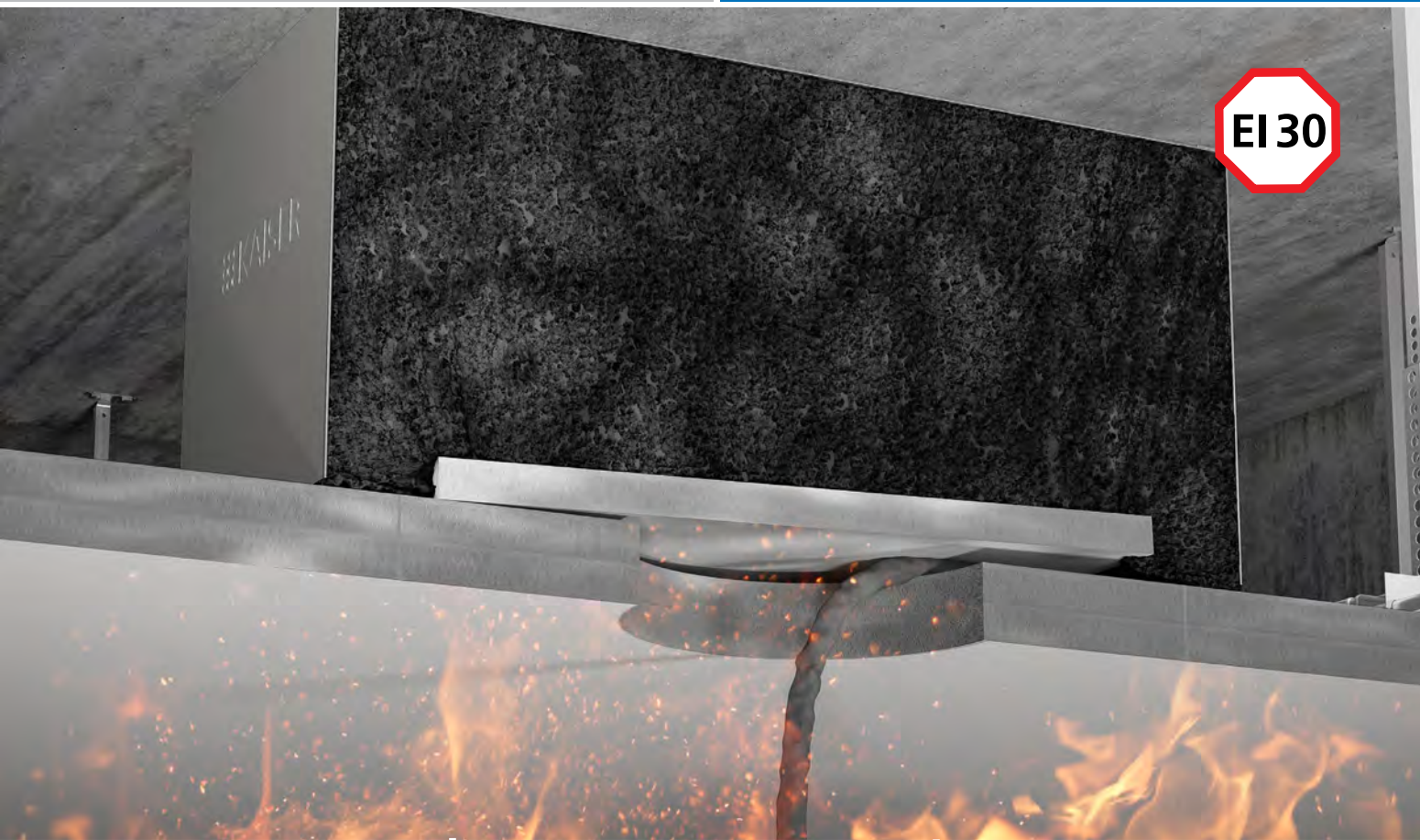

- 1 After determining the position of the light, use the template to mark the screw positions and the cutout.
- 2 Insert the housing into the component opening and align.
- 3 Fixing lugs with hole structure for fast, easy screw fitting to the fire-protection ceiling.
- 4 Interior consisting of a fire-protection material acting as a fire retardant and, in the event of a fire, an automatically closing plate.

General design approval applied for.

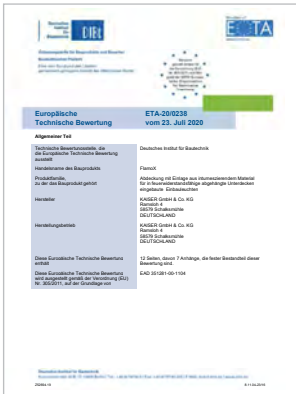

ETA
ETA-20/0238

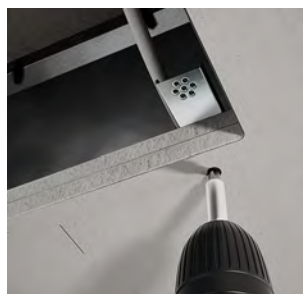



Partitions in fire protection ceilings. DS 90 / 74 mm and 90 / 120 mm ceiling penetration seal systems.

KAISER DS 90 / 74 mm und DS 90 / 120 mm ceiling penetration seal systems ensure that the ceiling maintains fire-resistance class EI30-EI90. To efficiently prevent the spread of fire and flue gases through cable penetrations and electrical installation conduits running through concrete or cellular concrete ceilings, their fire sealing must have the same fire-resistance class as the ceiling. The DS 90 ceiling penetration seal system accomplishes this easily, quickly and reliably.

- Secure, visible, certified fire sealing
- Sealing especially for ceiling penetrations
- Independent sealing without filling and lubrication
- Non-destructive retrofitting
- Also for mixed fitting of cable and conduit bundles
- Easy, quick installation from above



The DIBt approval proves the reliable quality of KAISER DS 90 / 74 mm and 120 mm box seal systems.



Divisible mounting sleeve for retrofitting of existing cables and conduits.

- 1 Divisible installation sleeve with edge protection made of intumescent material.
- 2 Retaining springs for quick, secure installation from above.
- 3 Cut-outs for receiving the metal plates and for fastening the box sealing system. Marking for positioning the screws.
- 4 Sealing flange ensures a clean, smoke-tight room partitioning of the component opening.

Formwork unit

For preparation of installation in concrete ceilings, KAISER provides a formwork unit for matching cut-outs.

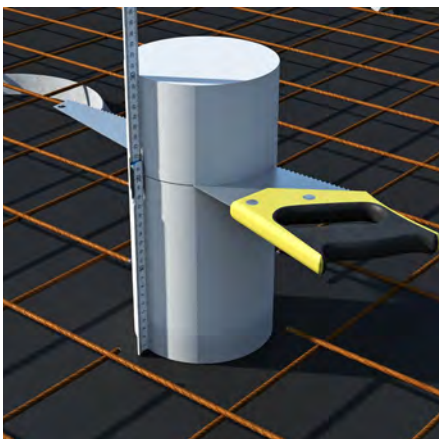

Adapt formwork unit to the ceiling thickness by cutting it to length.

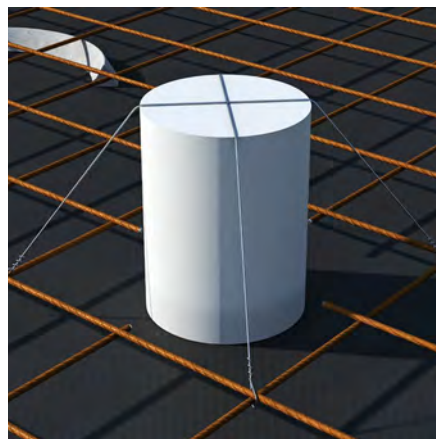

Fix the formwork unit to the reinforcement using the tie wire.

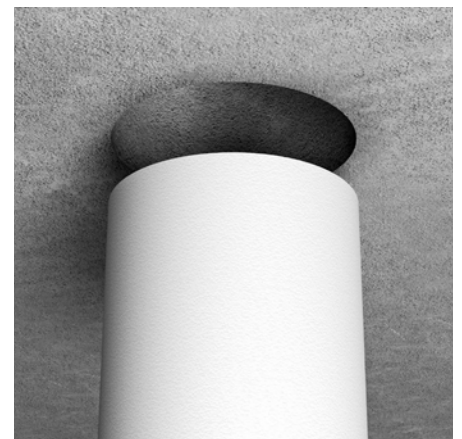

After formwork removal, remove the formwork unit from the component opening without leaving any residues.

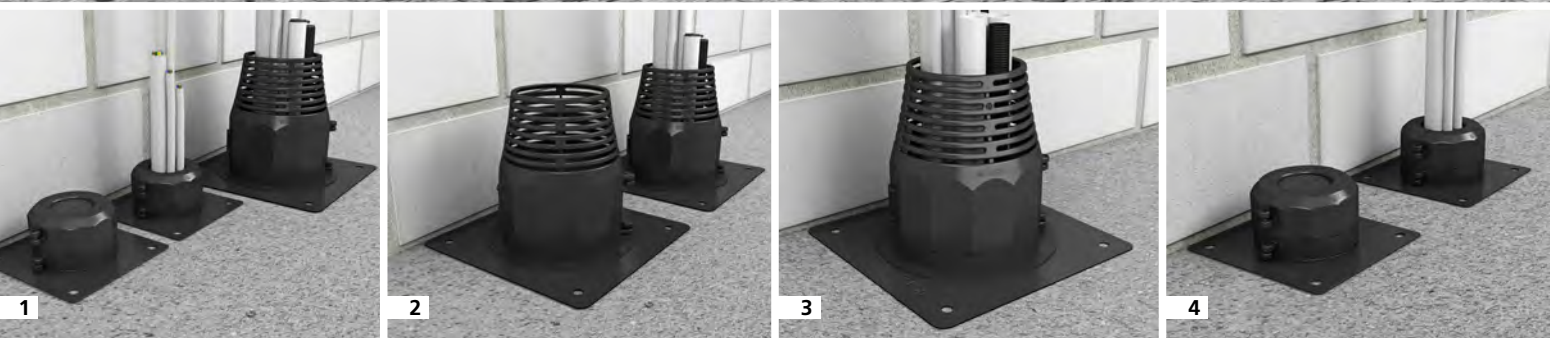

- 1 Mixed fixing of sheathed cables and conduits.
- 2 Can also be used as a reserve sealing.
- 3 Maximum assignment with sheathed cables Ø 29 mm and conduits up to M63.
- 4 Maximum assignment with sheathed cables Ø 15 mm and conduits up to M40.

Simple, fast and secure. Ceiling penetration seal systems for the ceiling upper surface.

KAISER DS 90 / 74 mm and DS 90 / 120 mm ceiling penetration seal systems are ideally suited to fire protection sealing of sheathed cables and electrical installation conduits. Through them, cables and conduits may be run as pure cable or conduit bundles up to full assignment, but mixed assignment is also possible. The ceiling penetration seal system can be installed quickly and easily from one side of the ceiling without the need for any tools. The use of additional fire protection materials is not necessary. The sealing flange on the mounting sleeve ensures smokeproof, clean room partitioning. As with the box sealing systems, non-destructive re-placement is also possible at any time with the ceiling penetration seal systems.

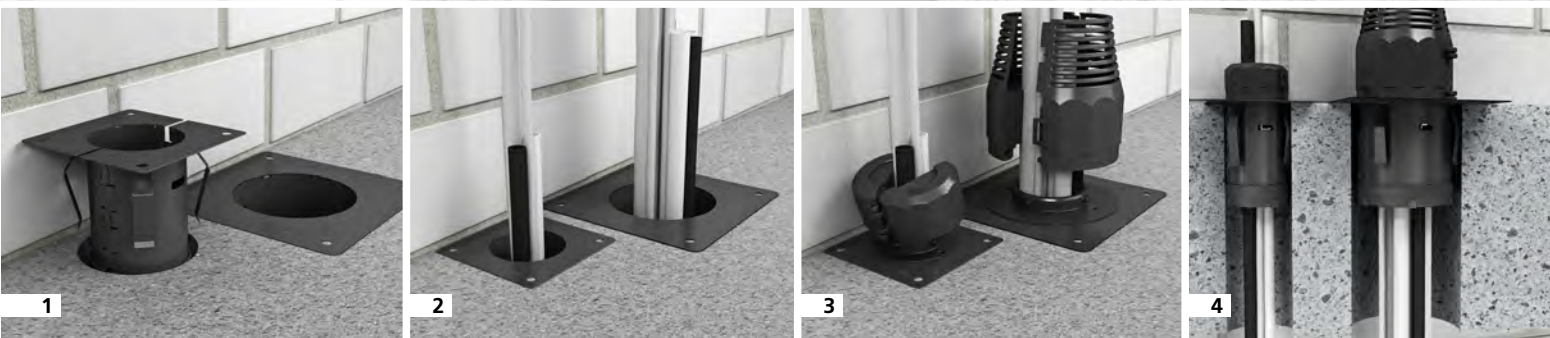

The installation is completed with simple, quick mounting from the top of the ceiling. The ceiling penetration seal system can also be retrofitted around existing cables and conduits. Non-destructive reassignment is possible at any time up to full assignment.

- 1 Insert the mounting sleeve into core drill holes \varnothing 100 mm or \varnothing 150 mm from the ceiling upper surface.
- 2 Feed sheathed cables and/or conduits through the installation sleeve.
- 3 Place the sealing cylinder around the cables or conduits and insert into the installation sleeve. Then engage the sealing element with the sealing cylinder.
- 4 Approved for concrete or cellular concrete ceilings from 150 - 300 mm ceiling thickness.

DS 90 / 74 mm ceiling penetration sealing system
Art. No. 9459-05



DS 90 / 120 mm ceiling penetration sealing system
Art. No. 9459-06



Formwork unit
Art. No. 9473-95/96

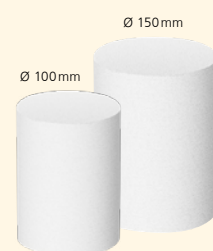



Protection against latent fire hazards. **ThermoX[®] installation housing.**

The intelligent housing system provides protection against the latent fire risk caused by the extreme heat of some lamp types. ThermoX[®] protects the vapour barrier foil and other surrounding materials in suspended ceilings and in the roof area from heat-generating halogen and LED lamps.

The housing prevents the latent fire hazard and ensures that the air tightness is maintained.

- Fire-preventing and airtight electrical installation
- Ceiling exit up to Ø 86 mm
- Installation either from above or below
- Also for retrofitting

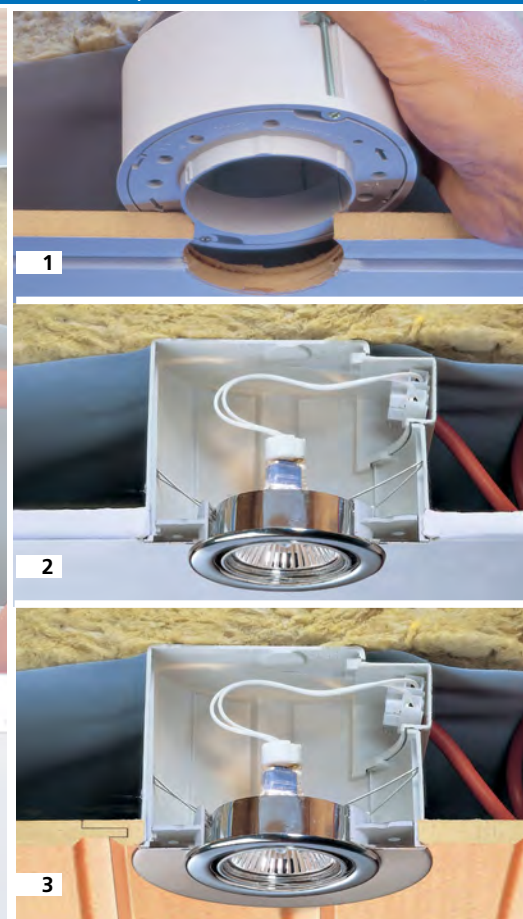
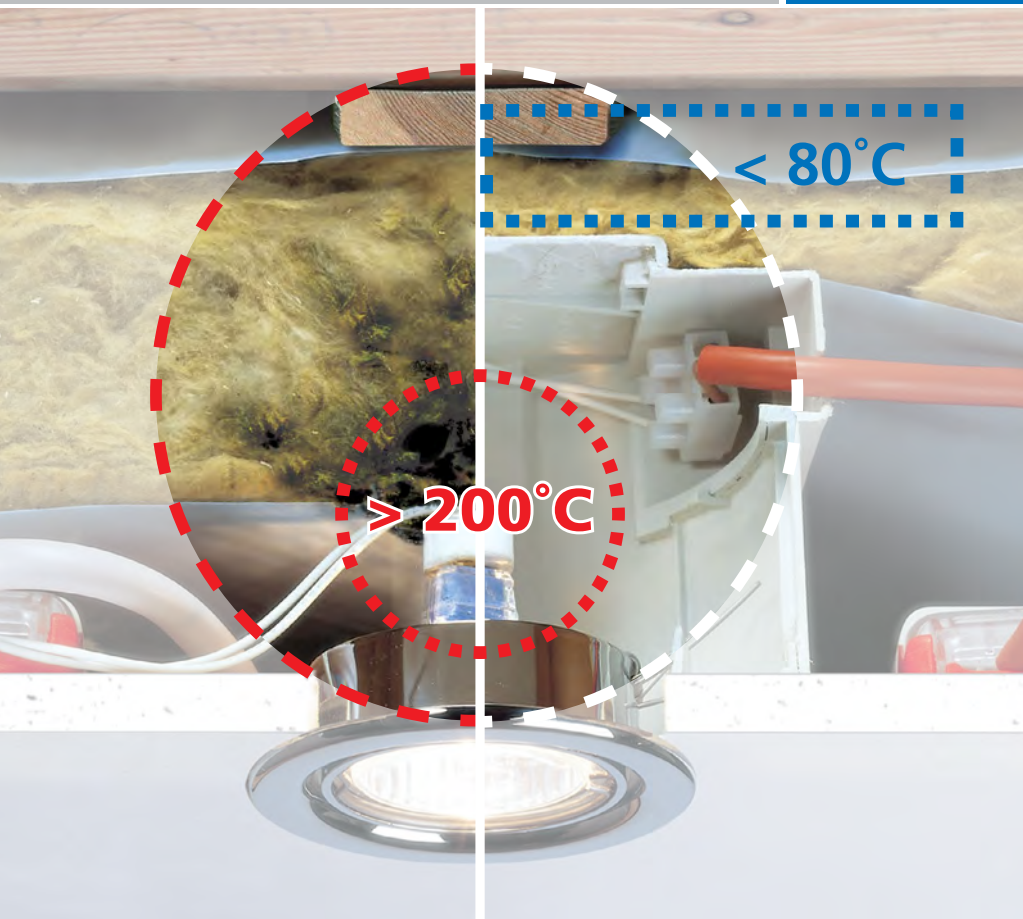

Latent fire hazard due to hot halogen lamps over 200°C already exists after a short burning time. The ThermoX® installation housing prevents the transfer of the extreme heat development to all surrounding materials.

- 1 The ThermoX® housing is installed during ceiling mounting.
- 2 The ThermoX® housing is retrofitted from below into a plasterboard ceiling.
- 3 The ThermoX® housing is retrofitted into a panel ceiling from below.

ThermoX® housing for halogen and swivelling LED lights
Art. No. 9300-01/02/03



ThermoX® front rings
Art. No. 9300-41/42/43



ThermoX® universal-housing with mineral fibreboard
Art. No. 9300-22



ThermoX® universal front part
Art. No. 9300-01/02/03



ThermoX® decorative coverings
Art. No. 9301-...



The matching Ø 120 mm cutter (Art. No. 1082-20) can be found on page 39.



Protection against latent fire hazards. ThermoX[®] LED installation housing.

ThermoX[®] LED installation housing for airtight installation of rigid and pivoting LED built-in lights in different ceiling constructions. The housing protects the surrounding material (vapour barrier foil, insulation etc.) against the high operating temperatures and the LED lights themselves from contamination.

- Fire-preventing and airtight
- For installation in insulated hollow ceilings
- Retrofitting from below
- Installation of the housing without tools
- Rear surface structure ensures optimal heat management
- Permanent, secure retention of the light in the housing



Air-tightness certificate

Guaranteed airtight housing for the energy-efficient electrical installation of lights. The appropriate certificate can be obtained from us or downloaded from our website.

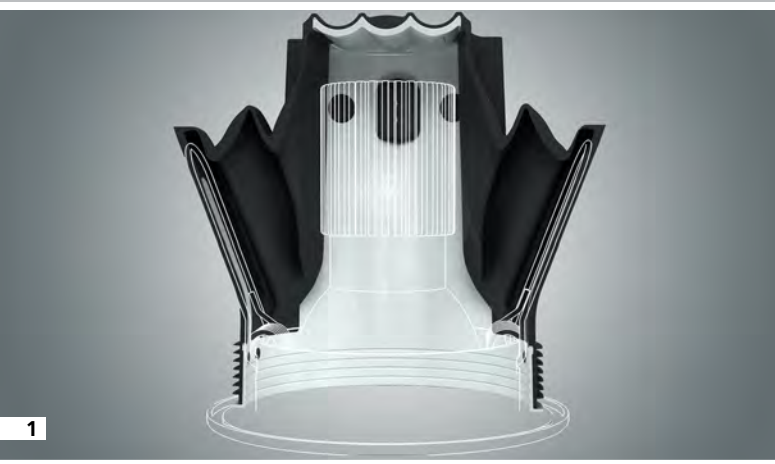

1



2



3

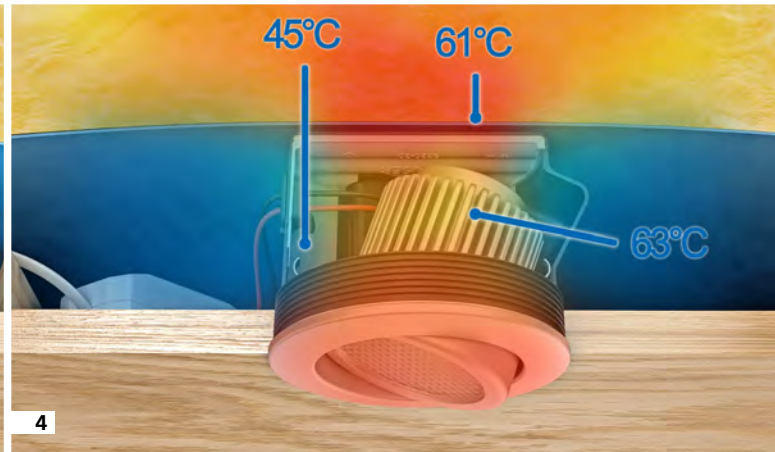

4

- 1 Guaranteed air tightness even with expanded fixing springs, thanks to flexible expanding pockets
- 2 Swivel pocket permits targeted alignment of the built-in downlight.
- 3 Flat housings enable use in low ceiling constructions, e.g. wooden slat construction.
- 4 Temperature profile for LED installation spotlights: the rear surface structure minimises pressure on the vapour barrier and ensures optimal heat dissipation.

The **ThermoX® LED** installation housing also provides other advantages. Its completely airtight design ensures that neither dust nor dirt from the intermediate ceiling can penetrate and affect the function of the heat sink. Maximum operating life is achieved due to thermal separation between the light and the operating device.



Suitable cutters for Ø 74 mm and Ø 86 mm cutter with countersinking can be found on page 39.



Fire and smoke proof walls in ship cabins.



Fire protection technology in shipbuilding.

Electrical installations on passenger ships, such as cruise ships, ferries or yachts, place the highest demands on functionality and above all on the safety of passengers and crew. We have transferred our experience from fire protection technology in buildings to the fast, demanding assembly needs of shipyards and cabin builders and the requirements of the shipping industry. From the fitter's point of view, a fire protection box has been developed which, not only has the most convenient installation, absolutely reliably prevents the spread of fire and smoke using category B0 to B15 partitioning surfaces.

The intelligent fire protection boxes for category B0 to B15 partitioning surfaces react in the shortest possible time in the event of a fire. HWD B15 cavity wall boxes protect against fire and smoke in the fire-protection zone and preserve the B15 function of the fire-protection wall for at least 30 minutes of flames.

Combinations of one-gang junction boxes in the standardised combination distance are possible simply by cutting off the marked area of the holding ring. Installation is as simple as with cavity wall boxes.

- For category B0 to B15 partitions
- Without encasing
- Also suitable for retrofitting
- With a fire-protection cover, it can also be used as a junction box

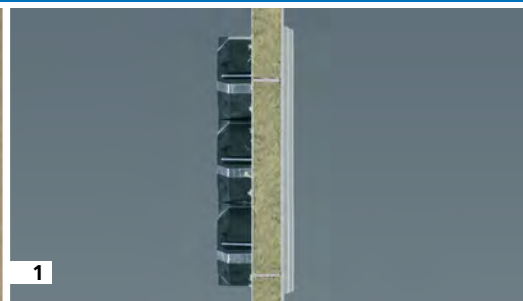
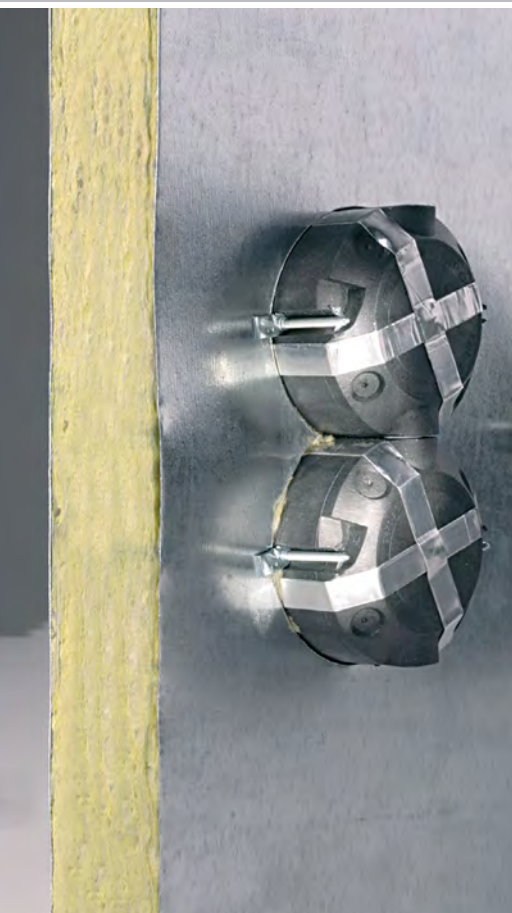

The certified equipment boxes are suitable for both metal-boarded and mineral shipbuilding walls. They offer the greatest possible safety and meet the requirements of current legislation.

1 Applicable for board thicknesses from 0.2 to 40 mm.

2 Multiple combination possible by separating the holding ring.

3 Accessory and one-gang junction boxes with zero tension technology are available for thin boarding.

<p>HWD B15 one-gang box Art. No. 9463-15</p> <p>44</p>	<p>HWD B15 one-gang box Art. No. 9461-15</p> <p>40</p>	<p>HWD B15 one-gang junction box Art. No. 9464-15</p> <p>54.5</p>
<p>HWD B15 one-gang box Art. No. 9463-14</p> <p>44</p>	<p>HWD B15 one-gang box Art. No. 9461-14</p> <p>40</p>	<p>HWD B15 one-gang junction box Art. No. 9464-14</p> <p>54.5</p> <p>Ø 74 mm</p>



The matching Ø 74 mm cutter (Art. No. 1083-74) can be found on page 39.

KAISER fire protection systems. At a glance.



www.kaiser-elektro.de/de_DE/service/projektlisten/brandschutz/



Installation in walls.

Flush-mounting fire-protection box | EI30 - EI120



Flush-mounting fire-protection box
1564-01 | Pg. 10

Fire protection boxes HWD 90 | EI30 - EI120, F30-B, F60-B



HWD 90 one-gang box
9463-01 | Pg. 12



HWD 90 accessory connection box
9464-01 | Pg. 12



HWD 90 electronics box
9462-94 | Pg. 12

HWD 68 fire protection boxes | EI30 - EI90



HWD 68 one-gang box
9463-02 | Pg. 16



HWD 68 accessory connection box
9464-02 | Pg. 16

Tools / accessories for HWD 90, HWD 68 and flush-mounted fire protection box



Universal opening cutter
1085-80

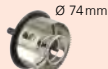

MULTI 4000 turbo cutter
1084-10



MULTI 4000 turbo cutter
1083-10



68/74 centering insert
1083-99



AMZ 2 stripping pliers
1190-02



Diamond grinding head
1088-02



HWD 30-120 fire-protection cover
1184-94



Support connector
9060-78



Support connector
9060-68



Installation for walls. Implementation and onboarding.

LS 90 and RS 90 cable and conduit sealing systems | EI30 - EI90

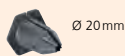

LS 90 cable sealing system
9459-01 | Pg. 18



RS 90 conduit sealing system
9459-02 | Pg. 18

DS 90 / 74 mm and DS 90 / 120 mm box sealing system | EI30 - EI90



DS 90 / 74 mm box sealing system
9459-03 | Pg. 18



DS 90 / 120 mm box sealing system
9459-04 | Pg. 18

Tools for sealing systems



Hardened metal cutter Ø 20 mm
1088-06



MULTI 4000 turbo cutter
1082-10

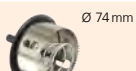

MULTI 4000 turbo cutter
1084-10

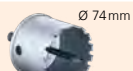

Hardened metal cutter
1083-74

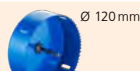

Bi-metallic cutter Ø 120 mm
1082-20



Sealing label
9473-91



Sealing label
9473-92

Accessories for sealing systems

Sealing plug

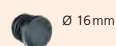

M16
1040-16 | Pg. 22

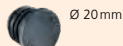

M20
1040-20 | Pg. 22

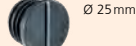

M25
1040-25 | Pg. 22



M32
1040-32 | Pg. 22



M40
1040-40 | Pg. 22

Installation in ceilings.



Fire-protection HWD 30 ceiling boxes | EI30 - EI90



HWD 30 ceiling box
9463-50 | Pg. 24



HWD 30 ceiling junction box
9464-50 | Pg. 24



HWD 30-120 fire-protection cover
1184-94 | Pg. 24

Fire-protection housing | EI30



FlamoX® fire-protection housing
9435-04 | Pg. 26



FlamoX® fire-protection housing
9435-03 | Pg. 26



FlamoX® fire-protection putty
9400-05

Ceiling penetration seal | EI30- EI90



DS 90 / 74 mm ceiling penetration sealing system
9459-05 | Pg. 18



DS 90 / 120 mm ceiling penetration sealing system
9459-06 | Pg. 18

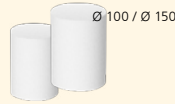

Formwork unit
9473-95/96 | Pg. 18

Accessories for sealing systems



Sealing label
9473-91



Sealing label
9473-92

Preventive fire protection



ThermoX® housing for halogen lights and swivelling LED lights
9300-01/02/03 | Pg. 32



ThermoX® universal housing with mineral fibre board
9300-22 | Pg. 32



Installation housings ThermoX® LED
9320-10 | Pg. 34



Installation housings ThermoX® LED
9320-11 | Pg. 34



Installation housings ThermoX® LED
9320-20 | Pg. 34



Installation housings ThermoX® LED
9320-21 | Pg. 34

Tools for HWD 30 and fire protection housing



Universal opening cutter
1085-80



MULTI 4000 turbo cutter
1083-10



MULTI 4000 turbo cutter
1084-10



Bi-metallic cutter Ø 86 mm
1087-86



Bi-metallic cutter Ø 120 mm
1082-20



VARIOCUT
1089-10 | 1089-00



68/74 centering insert
1083-99



Stripping pliers AMZ 2
1190-02

Installation in shipbuilding walls.



HWD B15 fire-protection box



HWD B15 one-gang box
9461-15 | Pg. 36



HWD B15 one-gang box
9463-15 | Pg. 36



HWD B15 one-gang junction box
9464-15 | Pg. 36



HWD B15 one-gang box
9461-14 | Pg. 36



HWD B15 one-gang box
9463-14 | Pg. 36



HWD B15 one-gang junction box
9464-14 | Pg. 36

Tools for HWD B15



Hardened metal cutter
1083-74



Universal opening cutter
1085-80

(PT: panel thickness | D: depth)

Systems and solutions for professional electrical installation work.

KAISER has been developing and producing systems and products as the basis for professional installation work since 1904. Planners and fitters all over the world use our practice-oriented solutions for their daily work in all installation areas.



Energy efficiency.

Innovative KAISER products help you to ensure compliance with the requirements of EU Directives and national regulations, such as the Energy Savings Regulations (EnEV).



Radiation protection.

The use of the new radiation protection boxes allows the radiation protection of the wall to be maintained without additional shielding measures.



Fire protection.

KAISER fire-protection systems provide reliable solutions for electrical installations in fire-protection walls and ceilings.



Construction.

KAISER has matching product system solutions for safe, durable and practical use in redevelopment, renovation and modernisation projects.



Sound insulation.

KAISER's innovative sound insulation boxes ensure compliance with the construction requirements for sound insulation walls, also for built-in installations.



Concrete construction.

Complete systems for on-site mixed concrete and precast concrete. Fully optimised to professional electrical installation work.

Technical information and advice

All further information on products, system solutions and communication media can be found on our website: www.kaiser-elektro.de

For any additional questions or information, please do not hesitate to contact our technical support team who will be happy to assist you: **+49 (0) 23 55 / 809-61** · technik@kaiser-elektro.de

KAISER GmbH & Co. KG

Ramsloh 4 · 58579 Schalksmuehle
GERMANY
Phone: +49 (0) 23 55 / 8090 · Fax: +49 (0) 23 55 / 80921
www.kaiser-elektro.de · info@kaiser-elektro.de

