

SYNTHESIS[®] LINE

battente



Synthesis[®] Line battente is ECLISSE solution that allows installing a hinged door flushing with the wall, this means a door with no frame: no jambs, no architraves.

According to your taste, the doors can be painted in the same colour of the wall, perfectly hiding from view, and blending in with the rest of the wall as much as possible in the pursuit of total continuity and formal rigor.

Alternatively, the door panel can be lacquered or decorated with finishing or prints that play them up, becoming real design elements.

SYNTESIS® LINE

battente



The same aesthetic and structural characteristics are present in the frameless sliding pocket door systems Syntesis® Line and Syntesis® Luce. Matching both solutions together, sliding and hinged, you can get a perfectly coherent and minimal result.

SYNTESIS® LINE

battente

TYPE: CHOOSE THE OPENING

PUSH DOOR

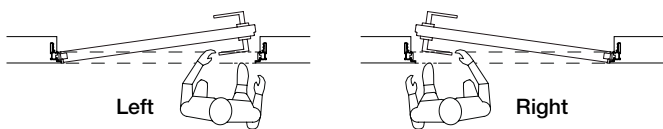

PULL DOOR

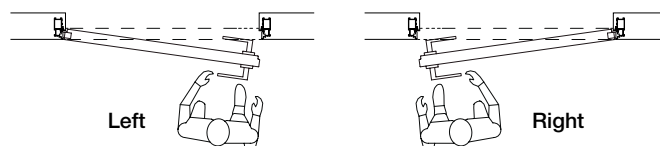

VERSION: WITH OR WITHOUT HEADER

The distinctive feature of Syntesis® Line battente is the possibility to install the doors flush with the ceiling with or without header in order to achieve a total integration among door, wall and ceiling.

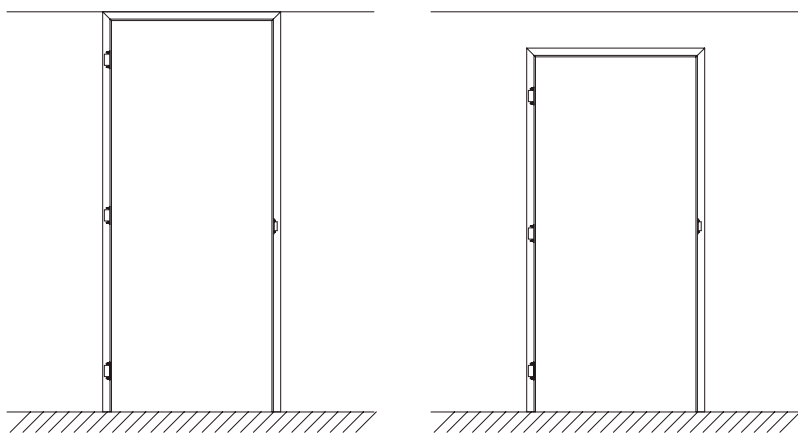

With header

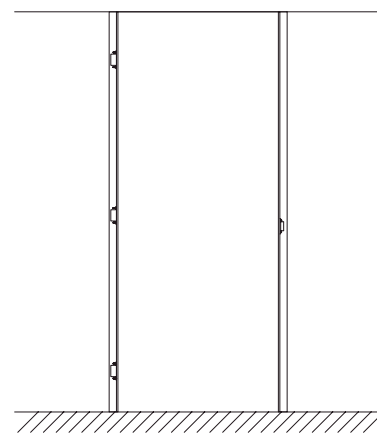

Without header

SUPPLY METHODS

COMPLETE SET



SINGLE ELEMENTS



The complete SET supply includes frame structure, door and hardware.

SYNTESIS® LINE

battente - THE ALUMINIUM FRAME



THE ADVANTAGES

- UNIQUE frame, for both stud and solid wall.
- Supplied in kit or pre-assembled with spacer panel in OSB 3, 25 mm thick in order to guarantee a perfect squaring of the frame (see point 7).
- Supplied with a plastic protection to avoid dirt and scratches in construction site.
- Bar code on the frame to identify the product.
- Door seal applicable on the frame, not on the door. Stable, easy to install, soft and aesthetically pleasant.
- Cover for door hinge to protect hinges from plaster (pull version).

Trademark

The frame is recognisable thanks to the trademark.



Very strong frame

The frame profile weighs about 2 kg/m.

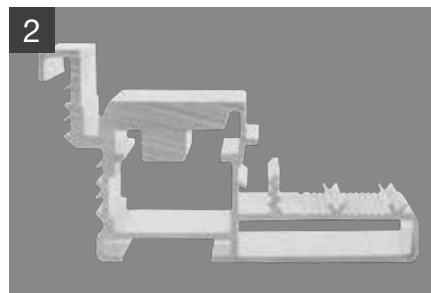

Long lasting

The aluminium frame is firstly subjected to a phosphate treatment against oxidation and then it is primer-coated to facilitate paint cohesion.



6 adjustable clamps

The clamps are adjustable for height and prepared to be easily fixed to solid wall.



Quote 100

To help the installer finding the "0" quote.

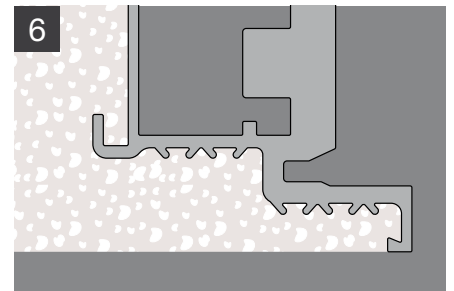

NO cracks!

The frame profile is specially designed to avoid cracks.

SYNTHESIS® LINE

battente - THE DOOR



THE ADVANTAGES

- The door is recognisable thanks to the trademark
- Primer-coated to favour cohesion of wall paint and lacquer (both opaque and glossy)
- Universal outline adaptable to opening side (right or left)
- 45 mm thickness
- Full hollow core with double solid wood perimeter to improve inflexibility
- Border all along the perimeter
- Door panel with height starting from H 2300 mm, are provided with a tensioning rod that improve the door flatness
- The door panel is supplied only with a hole for handle; it's possible to install key lock or turn knob lock creating a second hole during installation.

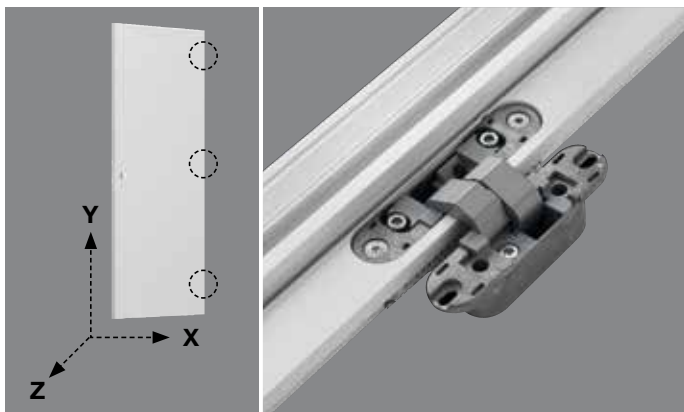

HINGES

3 Triple adjustable hinges (height, width, depth) for a perfect calibration of the perimeter size.

Note: when the door weighs more than 50 kg (max 65 kg), 4 hinges are needed (increase t 60,00).

MAGNETIC LOCK

Magnetic lock

It has modern design and minimal lines; it remains "flush" and guarantees an extraordinary softness while closing.

Eccentric strike plate

- Minimal design, it remains "flush"
- Eccentric: it allows fixing little installation imperfections, guaranteeing a perfect locking.

Note: it comes standard without lock or lock with key. Turn knob lock on request.



SYNTESIS® LINE

battente - APPLICATIONS

The frame fits both with stud and solid wall.

For solid wall 6 clamps are cemented in the special spaces created in the wall.

For stud wall the frame is fixed with screws to the metal structure through the existing holes.

PUSH DOOR

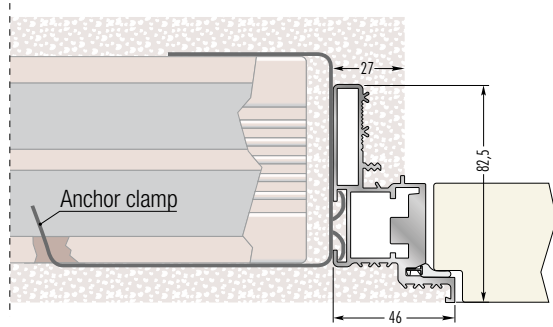

Frame on solid wall

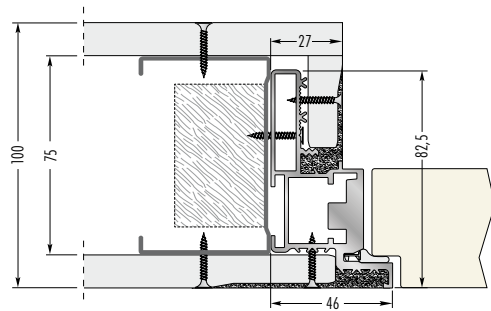

Frame on stud wall with one plate
Finished wall thickness 100 mm

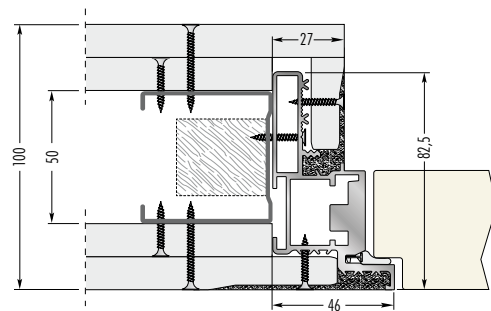

Frame on stud wall with two plates
Finished wall thickness 100 mm

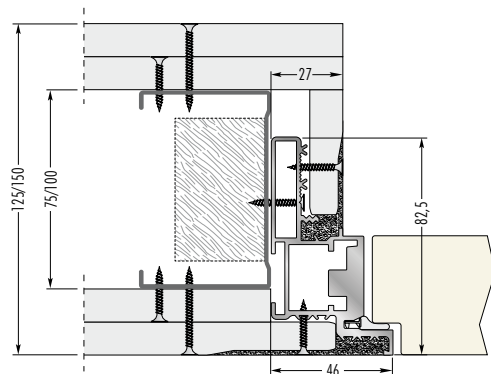

Frame on stud wall with three plates
Finished wall thickness 125/150 mm

PULL DOOR

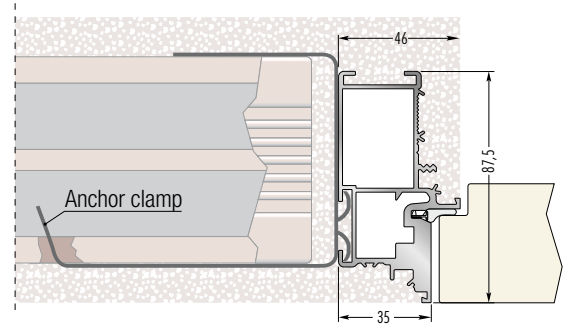

Frame on solid wall

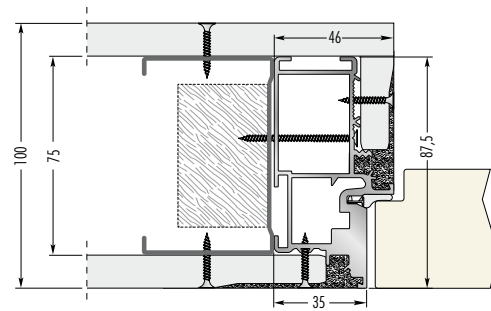

Frame on stud wall with one plate
Finished wall thickness 100 mm

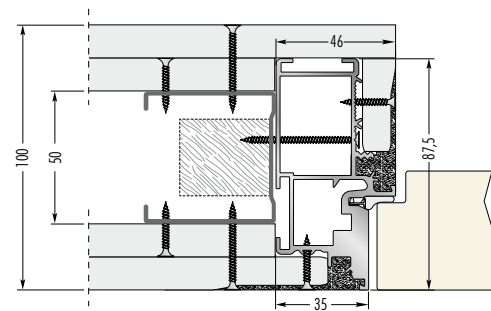

Frame on stud wall with two plates
Finished wall thickness 100 mm

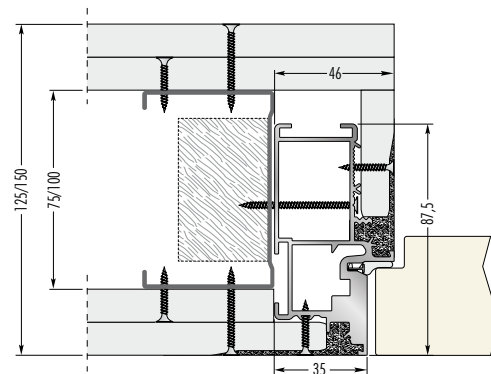

Frame on stud wall with three plates
Finished wall thickness 125/150 mm

SYNTESIS® LINE

battente - DIMENSIONS

PUSH DOOR

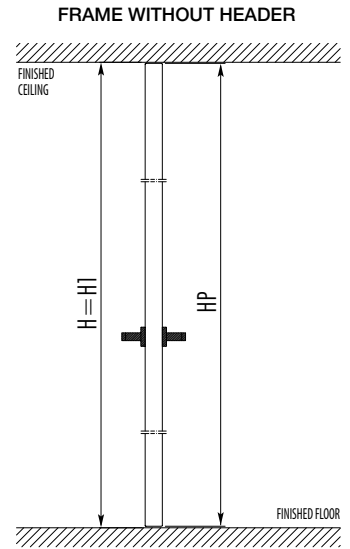
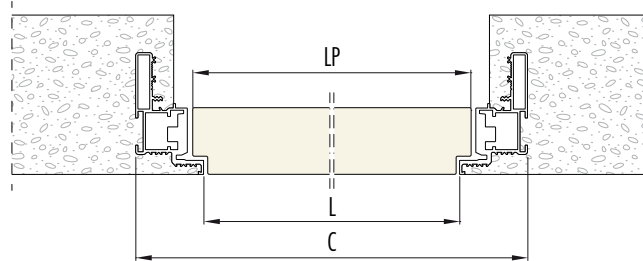
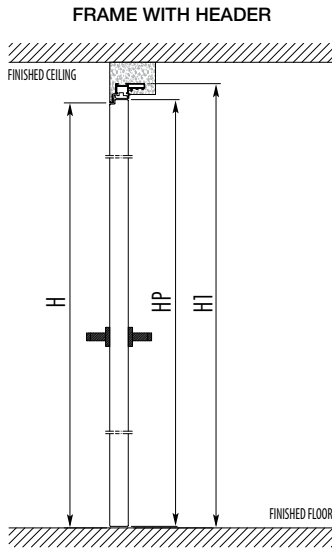

PULL DOOR

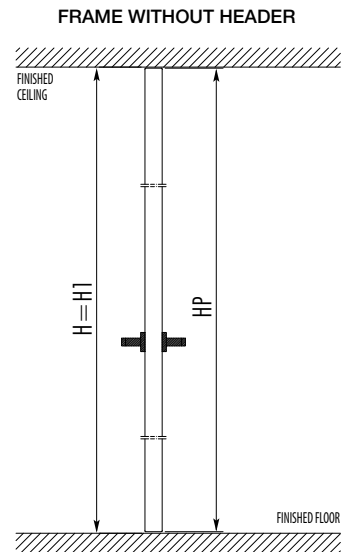
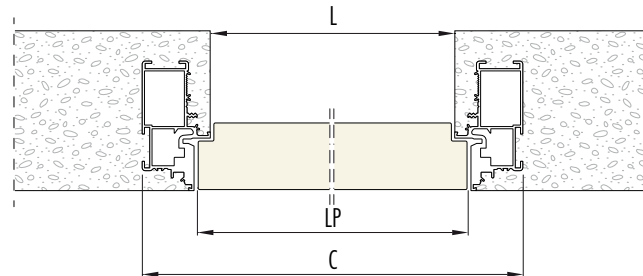
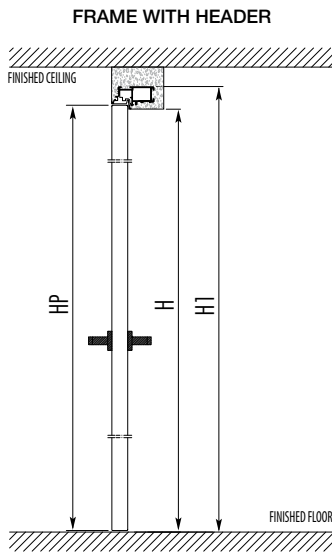

FRAME WITH RAIL						FRAME WITHOUT RAIL					
PASSAGE SIZE		OVERALL DIMENSIONS		DOOR PANEL - 45 mm thick		PASSAGE SIZE		OVERALL DIMENSIONS		DOOR PANEL - 45 mm thick	
L	H	C	H1	LP	HP	L	H	C	H1	LP	HP
600	2100/2400	692	2146/2446	616	2104/2404	600	2700	692	2700	616	2693
650	2100/2400	742	2146/2446	666	2104/2404	650	2700	742	2700	666	2693
700	2100/2400	792	2146/2446	716	2104/2404	700	2700	792	2700	716	2693
750	2100/2400	842	2146/2446	766	2104/2404	750	2700	842	2700	766	2693
800	2100/2400	892	2146/2446	816	2104/2404	800	2700	892	2700	816	2693
850	2100/2400	942	2146/2446	866	2104/2404	850	2700	942	2700	866	2693
900	2100/2400	992	2146/2446	916	2104/2404	900	2700	992	2700	916	2693
950	2100/2400	1042	2146/2446	966	2104/2404	950	2700	1042	2700	966	2693
1000	2100/2400	1092	2146/2446	1016	2104/2404	1000	2700	1092	2700	1016	2693

Dimensions are given in mm

- ▶ INTERVAL FOR HEIGHT EVERY 50 mm, from 1800 mm to 2700 mm
- ▶ VERSION WITH HEADER: HEIGHT OVERALL DIMENSION IS ALWAYS MORE THAN 46 mm COMPARED TO HEIGHT SIZE H
- ▶ VERSION WITH HEADER: IT'S POSSIBLE TO HAVE A VARIATION WITH HEIGHT OVERALL DIMENSION 2700 mm AND PASSAGE SIZE 2654 mm

SYNTESIS® LINE

battente - PRICE

STANDARD	COMPLETE SET
ALUMINIUM FRAME + DOOR + HARDWARE FOR HANDLE WITH OR WITHOUT KEY	

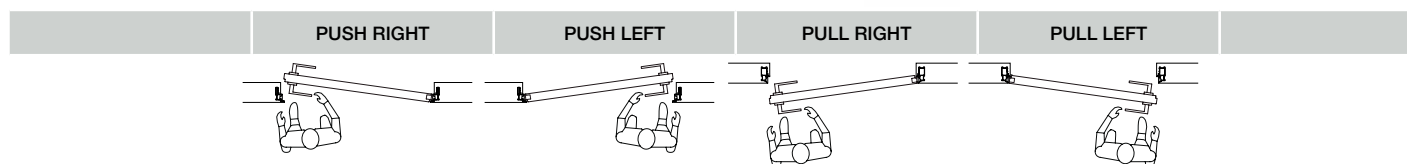

PASSAGE SIZE LxH in mm	CODE	CODE	CODE	CODE	PRICE
600x2000	ESB_FMSD2P	ESB_FMSS2P	ESB_FMTD2P	ESB_FMST2P	€ 1.024,67
600x2100	ESB_060SBSD2P	ESB_060SBSS2P	ESB_060SBTD2P	ESB_060SBTS2P	€ 1.058,23
600x2400	ESB_060SRSD2P	ESB_060SRSS2P	ESB_060SRTD2P	ESB_060SRST2P	€ 1.244,41
700x2000	ESB_FMSD2P	ESB_FMSS2P	ESB_FMTD2P	ESB_FMST2P	€ 1.056,09
700x2100*	ESB_070SBSD2P	ESB_070SBSS2P	ESB_070SBTD2P	ESB_070SBTS2P	€ 970,49
700x2400	ESB_070SRSD2P	ESB_070SRSS2P	ESB_070SRTD2P	ESB_070SRST2P	€ 1.244,41
800x2000	ESB_FMSD2P	ESB_FMSS2P	ESB_FMTD2P	ESB_FMST2P	€ 1.056,09
800x2100*	ESB_080SBSD2P	ESB_080SBSS2P	ESB_080SBTD2P	ESB_080SBTS2P	€ 970,49
800x2400*	ESB_080SRSD2P	ESB_080SRSS2P	ESB_080SRTD2P	ESB_080SRST2P	€ 1.141,69
900x2000	ESB_FMSD2P	ESB_FMSS2P	ESB_FMTD2P	ESB_FMST2P	€ 1.209,15
900x2100	ESB_090SBSD2P	ESB_090SBSS2P	ESB_090SBTD2P	ESB_090SBTS2P	€ 1.144,90
900x2400	ESB_090SRSD2P	ESB_090SRSS2P	ESB_090SRTD2P	ESB_090SRST2P	€ 1.347,13
1000x2000	ESB_FMSD2P	ESB_FMSS2P	ESB_FMTD2P	ESB_FMST2P	€ 1.270,39
1000x2100	ESB_100SBSD2P	ESB_100SBSS2P	ESB_100SBTD2P	ESB_100SBTS2P	€ 1.203,75
1000x2400	ESB_100SRSD2P	ESB_100SRSS2P	ESB_100SRTD2P	ESB_100SRST2P	€ 1.415,61

▶ In order to specify if you want the frame pre-assembled or in KIT put **K = KIT** or **A = ASSEMBLED**, in the blank space ()
EXAMPLE: 600X2000 COMPLETE KIT = CODE: ESBKFMSD2P

* DELIVERY TIME: 10 working days FOR SIZES 700X2100 mm, 800x2100 mm AND 800x2400 mm; OTHER SIZES: 30 working days.

▶ LOCK FOR HANDLE WITH TURN KNOB ON REQUEST AT THE SAME PRICE

▶ N° PACKAGES: 3

▶ PRODUCTION WITH INTERVALS EVERY 50 MM (FOR PRICES SEE SUPERIOR SIZE);

E.G.: A FRAME WITH PASSAGE SIZE MM 650X2400 WILL HAVE THE PRICE OF A MM 700X2400 FRAME**

**EXCEPT SIZES MM 650X2100 (PRICE € 1.068,12), MM 750X2100 (PRICE € 1.068,12), AND MM 750X2400 (PRICE € 1.256,04)

ALL PRICES DO NOT INCLUDE TAX

SYNTESIS® LINE

battente - PRICE

NON STANDARD

COMPLETE SET

ALUMINIUM FRAME + DOOR + HARDWARE
FOR HANDLE WITH OR WITHOUT KEY

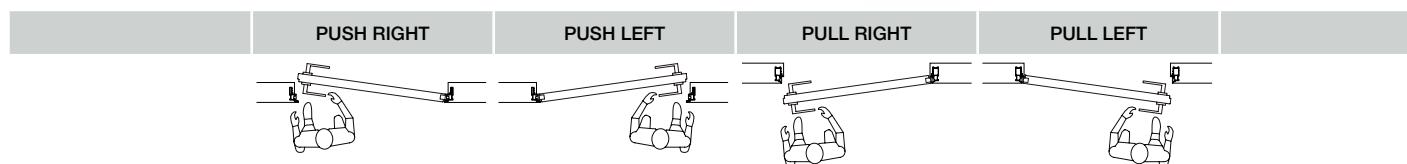

PASSAGE SIZE LxH in mm	CODE	CODE	CODE	CODE	PRICE
600x2200	ESB_FMSD2P	ESB_FMSS2P	ESB_FMTD2P	ESB_FMTS2P	€ 1.270,63
600x2300	ESB_FMSD2P	ESB_FMSS2P	ESB_FMTD2P	ESB_FMTS2P	€ 1.270,63
600x2500	ESB_FMSD2P	ESB_FMSS2P	ESB_FMTD2P	ESB_FMTS2P	€ 1.654,86
600x2600	ESB_FMSD2P	ESB_FMSS2P	ESB_FMTD2P	ESB_FMTS2P	€ 1.832,75
600x2700*	ESB_FMSD2P	ESB_FMSS2P	ESB_FMTD2P	ESB_FMTS2P	€ 2.177,45
700x2200	ESB_FMSD2P	ESB_FMSS2P	ESB_FMTD2P	ESB_FMTS2P	€ 1.227,29
700x2300	ESB_FMSD2P	ESB_FMSS2P	ESB_FMTD2P	ESB_FMTS2P	€ 1.227,29
700x2500	ESB_FMSD2P	ESB_FMSS2P	ESB_FMTD2P	ESB_FMTS2P	€ 1.598,58
700x2600	ESB_FMSD2P	ESB_FMSS2P	ESB_FMTD2P	ESB_FMTS2P	€ 1.769,78
700x2700*	ESB_FMSD2P	ESB_FMSS2P	ESB_FMTD2P	ESB_FMTS2P	€ 1.997,69
800x2200	ESB_FMSD2P	ESB_FMSS2P	ESB_FMTD2P	ESB_FMTS2P	€ 1.227,29
800x2300	ESB_FMSD2P	ESB_FMSS2P	ESB_FMTD2P	ESB_FMTS2P	€ 1.227,29
800x2500	ESB_FMSD2P	ESB_FMSS2P	ESB_FMTD2P	ESB_FMTS2P	€ 1.598,58
800x2600	ESB_FMSD2P	ESB_FMSS2P	ESB_FMTD2P	ESB_FMTS2P	€ 1.769,78
800x2700*	ESB_FMSD2P	ESB_FMSS2P	ESB_FMTD2P	ESB_FMTS2P	€ 1.997,69
900x2200	ESB_FMSD2P	ESB_FMSS2P	ESB_FMTD2P	ESB_FMTS2P	€ 1.448,78
900x2300	ESB_FMSD2P	ESB_FMSS2P	ESB_FMTD2P	ESB_FMTS2P	€ 1.448,78
900x2500	ESB_FMSD2P	ESB_FMSS2P	ESB_FMTD2P	ESB_FMTS2P	€ 1.886,41
900x2600	ESB_FMSD2P	ESB_FMSS2P	ESB_FMTD2P	ESB_FMTS2P	€ 2.087,57
900x2700*	ESB_FMSD2P	ESB_FMSS2P	ESB_FMTD2P	ESB_FMTS2P	€ 2.357,21
1000x2200	ESB_FMSD2P	ESB_FMSS2P	ESB_FMTD2P	ESB_FMTS2P	€ 1.521,54
1000x2300	ESB_FMSD2P	ESB_FMSS2P	ESB_FMTD2P	ESB_FMTS2P	€ 1.521,54
1000x2500	ESB_FMSD2P	ESB_FMSS2P	ESB_FMTD2P	ESB_FMTS2P	€ 1.981,64
1000x2600	ESB_FMSD2P	ESB_FMSS2P	ESB_FMTD2P	ESB_FMTS2P	€ 2.194,57
1000x2700*	ESB_FMSD2P	ESB_FMSS2P	ESB_FMTD2P	ESB_FMTS2P	€ 2.477,05

▶ In order to specify if you want the frame pre-assembled or in KIT put **K = KIT** or **A = ASSEMBLED**, in the blank space ()
EXAMPLE: 600X2200 COMPLETE KIT = CODE: ESBKFMSD2P

* AVAILABLE WITH OR WITHOUT HEADER. VERSION WITH HEADER: IT'S POSSIBLE TO HAVE A VARIATION WITH HEIGHT OVERALL DIMENSION mm 2700 AND PASSAGE SIZE mm 2654

▶ LOCK FOR HANDLE WITH TURN KNOB ON REQUEST AT THE SAME PRICE

▶ N° PACKAGES: 3

▶ DELIVERY TIME: 30 working days

▶ PRODUCTION WITH INTERVALS EVERY 50 MM (FOR PRICES SEE SUPERIOR SIZE); E.G.: A FRAME WITH PASSAGE SIZE MM 650X2500 WILL HAVE THE PRICE OF A MM 700X2500 FRAME

▶ FOR HEIGHT DIMENSIONS BETWEEN mm 1800 AND mm 1950 ASK FOR OFFER

ALL PRICES DO NOT INCLUDE TAX

SYNTHESIS® LINE

battente - PRICE

STANDARD	ALUMINIUM FRAME
	KIT OR PRE-ASSEMBLED

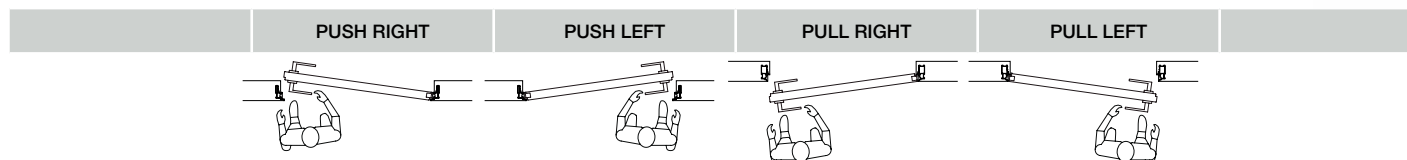

PASSAGE SIZE LxH in mm	CODE	CODE	CODE	CODE	PRICE
600x2000	ESB_FMSD	ESB_FMSS	ESB_FMTD	ESB_FMTS	€ 474,22
600x2100	ESB_060SBSD	ESB_060SBSS	ESB_060SBTD	ESB_060SBTS	€ 474,22
600x2400	ESB_060SRSD	ESB_060SRSS	ESB_060SRTD	ESB_060SRTS	€ 522,59
700x2000	ESB_FMSD	ESB_FMSS	ESB_FMTD	ESB_FMTS	€ 516,17
700x2100*	ESB_070SBSD	ESB_070SBSS	ESB_070SBTD	ESB_070SBTS	€ 516,17
700x2400	ESB_070SRSD	ESB_070SRSS	ESB_070SRTD	ESB_070SRTS	€ 557,90
800x2000	ESB_FMSD	ESB_FMSS	ESB_FMTD	ESB_FMTS	€ 535,43
800x2100*	ESB_080SBSD	ESB_080SBSS	ESB_080SBTD	ESB_080SBTS	€ 535,43
800x2400*	ESB_080SRSD	ESB_080SRSS	ESB_080SRTD	ESB_080SRTS	€ 597,49
900x2000	ESB_FMSD	ESB_FMSS	ESB_FMTD	ESB_FMTS	€ 558,11
900x2100	ESB_090SBSD	ESB_090SBSS	ESB_090SBTD	ESB_090SBTS	€ 558,11
900x2400	ESB_090SRSD	ESB_090SRSS	ESB_090SRTD	ESB_090SRTS	€ 614,18
1000x2000	ESB_FMSD	ESB_FMSS	ESB_FMTD	ESB_FMTS	€ 587,22
1000x2100	ESB_100SBSD	ESB_100SBSS	ESB_100SBTD	ESB_100SBTS	€ 587,22
1000x2400	ESB_100SRSD	ESB_100SRSS	ESB_100SRTD	ESB_100SRTS	€ 634,30

► In order to specify if you want the frame pre-assembled or in KIT put **K = KIT** or **A = ASSEMBLED**, in the blank space ()
 EXAMPLE: 600X2000 COMPLETE KIT = CODE: ESBKFMSD

* DELIVERY TIME: 10 working days FOR SIZES 700X2100 mm, 800x2100 mm AND 800x2400 mm; OTHER SIZES: 15 working days.

► HARDWARE (MAGNETIC LOCK, HINGES AND DOOR SEAL) IS NOT INCLUDED; SEE PAGE 14

► N° PACKAGES: 1

► PRODUCTION WITH INTERVALS EVERY 50 MM (FOR PRICES SEE SUPERIOR SIZE); E.G.: A FRAME WITH PASSAGE SIZE MM 650X2400 WILL HAVE THE PRICE OF A MM 700X2400 FRAME

ALL PRICES DO NOT INCLUDE TAX

SYNTESIS® LINE

battente - PRICE

NON STANDARD

ALUMINIUM FRAME

KIT OR PRE-ASSEMBLED

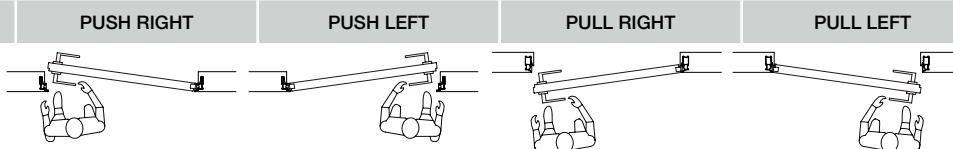

PASSAGE SIZE LxH in mm	CODE	CODE	CODE	CODE	PRICE
600x2200	ESB_FMSD	ESB_FMSS	ESB_FMTD	ESB_FMTS	€ 550,41
600x2300	ESB_FMSD	ESB_FMSS	ESB_FMTD	ESB_FMTS	€ 550,41
600x2500	ESB_FMSD	ESB_FMSS	ESB_FMTD	ESB_FMTS	€ 716,47
600x2600	ESB_FMSD	ESB_FMSS	ESB_FMTD	ESB_FMTS	€ 792,66
600x2700*	ESB_FMSD	ESB_FMSS	ESB_FMTD	ESB_FMTS	€ 895,38
700x2200	ESB_FMSD	ESB_FMSS	ESB_FMTD	ESB_FMTS	€ 572,45
700x2300	ESB_FMSD	ESB_FMSS	ESB_FMTD	ESB_FMTS	€ 572,45
700x2500	ESB_FMSD	ESB_FMSS	ESB_FMTD	ESB_FMTS	€ 759,27
700x2600	ESB_FMSD	ESB_FMSS	ESB_FMTD	ESB_FMTS	€ 832,46
700x2700*	ESB_FMSD	ESB_FMSS	ESB_FMTD	ESB_FMTS	€ 930,90
800x2200	ESB_FMSD	ESB_FMSS	ESB_FMTD	ESB_FMTS	€ 595,35
800x2300	ESB_FMSD	ESB_FMSS	ESB_FMTD	ESB_FMTS	€ 595,35
800x2500	ESB_FMSD	ESB_FMSS	ESB_FMTD	ESB_FMTS	€ 802,07
800x2600	ESB_FMSD	ESB_FMSS	ESB_FMTD	ESB_FMTS	€ 876,12
800x2700*	ESB_FMSD	ESB_FMSS	ESB_FMTD	ESB_FMTS	€ 974,56
900x2200	ESB_FMSD	ESB_FMSS	ESB_FMTD	ESB_FMTS	€ 627,45
900x2300	ESB_FMSD	ESB_FMSS	ESB_FMTD	ESB_FMTS	€ 627,45
900x2500	ESB_FMSD	ESB_FMSS	ESB_FMTD	ESB_FMTS	€ 844,87
900x2600	ESB_FMSD	ESB_FMSS	ESB_FMTD	ESB_FMTS	€ 914,21
900x2700*	ESB_FMSD	ESB_FMSS	ESB_FMTD	ESB_FMTS	€ 1.013,50
1000x2200	ESB_FMSD	ESB_FMSS	ESB_FMTD	ESB_FMTS	€ 671,53
1000x2300	ESB_FMSD	ESB_FMSS	ESB_FMTD	ESB_FMTS	€ 671,53
1000x2500	ESB_FMSD	ESB_FMSS	ESB_FMTD	ESB_FMTS	€ 887,67
1000x2600	ESB_FMSD	ESB_FMSS	ESB_FMTD	ESB_FMTS	€ 972,84
1000x2700*	ESB_FMSD	ESB_FMSS	ESB_FMTD	ESB_FMTS	€ 1.110,23

▶ In order to specify if you want the frame pre-assembled or in KIT put **K = KIT** or **A = ASSEMBLED**, in the blank space ()
EXAMPLE: 600X2200 COMPLETE KIT = CODE: ESBKFMSD

* AVAILABLE WITH OR WITHOUT HEADER. VERSION WITH HEADER: IT'S POSSIBLE TO HAVE A VARIATION WITH HEIGHT OVERALL DIMENSION mm 2700 AND PASSAGE SIZE mm 2654

▶ HARDWARE (MAGNETIC LOCK, HINGES AND DOOR SEAL) IS NOT INCLUDED; SEE PAGE 14

▶ N° PACKAGES: 1

▶ DELIVERY TIME: 15 working days

▶ PRODUCTION WITH INTERVALS EVERY 50 MM (FOR PRICES SEE SUPERIOR SIZE); E.G.: A FRAME WITH PASSAGE SIZE MM 650X2500 WILL HAVE THE PRICE OF A MM 700X2500 FRAME

▶ FOR HEIGHT DIMENSIONS BETWEEN MM 1800 AND MM 1950 REQUEST A PREVENTIVE

ALL PRICES DO NOT INCLUDE TAX

SYNTHESIS® LINE

battente - PRICE

STANDARD

RAW DOOR WITH PRIMER ONLY



PUSH RIGHT/ PULL LEFT

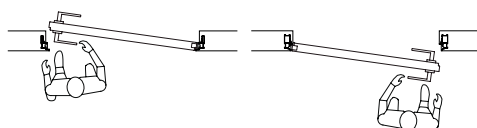

PUSH LEFT/ PULL RIGHT

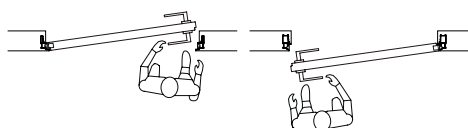

PASSAGE SIZE LxH in mm	CODE	CODE	PRICE
600x2000	EPSBSD060200	EPSBSS060200	€ 418,78
600x2100	EPSBSD060210	EPSBSS060210	€ 464,79
600x2400	EPSBSD060240	EPSBSS060240	€ 586,06
700x2000	EPSBSD070200	EPSBSS070200	€ 439,73
700x2100*	EPSBSD070210	EPSBSS070210	€ 505,90
700x2400	EPSBSD070240	EPSBSS070240	€ 586,06
800x2000	EPSBSD080200	EPSBSS080200	€ 471,21
800x2100*	EPSBSD080210	EPSBSS080210	€ 538,00
800x2400*	EPSBSD080240	EPSBSS080240	€ 631,27
900x2000	EPSBSD090200	EPSBSS090200	€ 515,91
900x2100	EPSBSD090210	EPSBSS090210	€ 600,35
900x2400	EPSBSD090240	EPSBSS090240	€ 666,66
1000x2000	EPSBSD100200	EPSBSS100200	€ 546,90
1000x2100	EPSBSD100210	EPSBSS100210	€ 650,07
1000x2400	EPSBSD100240	EPSBSS100240	€ 722,86

* DELIVERY TIME: 10 working days FOR SIZES 700X2100 mm, 800x2100 mm AND 800x2400 mm; OTHER SIZES: 15 working days.

▶ HARDWARE (MAGNETIC LOCK, HINGES AND DOOR SEAL) IS NOT INCLUDED; SEE PAGE 14

▶ N° PACKAGES: 1

▶ PRODUCTION WITH INTERVALS EVERY 50 MM (FOR PRICES SEE SUPERIOR SIZE);
E.G.: A FRAME WITH PASSAGE SIZE MM 650X2400 WILL HAVE THE PRICE OF A MM 700X2400 FRAME**

ALL PRICES DO NOT INCLUDE TAX

SYNTHESIS® LINE

battente - PRICE

NON STANDARD

RAW DOOR WITH PRIMER ONLY



PUSH RIGHT/ PULL LEFT

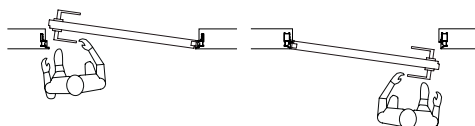

PUSH LEFT/ PULL RIGHT

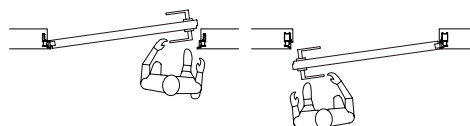

PASSAGE SIZE LxH in mm	CODE	CODE	PRICE
600x2200	EPSBSD060220	EPSBSS060220	€ 614,38
600x2300	EPSBSD060230	EPSBSS060230	€ 614,38
600x2500	EPSBSD060250	EPSBSS060250	€ 822,85
600x2600	EPSBSD060260	EPSBSS060260	€ 930,00
600x2700	EPSBSD060270	EPSBSS060270	€ 1.134,18
700x2200	EPSBSD070220	EPSBSS070220	€ 614,38
700x2300	EPSBSD070230	EPSBSS070230	€ 614,38
700x2500	EPSBSD070250	EPSBSS070250	€ 822,85
700x2600	EPSBSD070260	EPSBSS070260	€ 930,00
700x2700	EPSBSD070270	EPSBSS070270	€ 1.134,18
800x2200	EPSBSD080220	EPSBSS080220	€ 640,39
800x2300	EPSBSD080230	EPSBSS080230	€ 640,39
800x2500	EPSBSD080250	EPSBSS080250	€ 867,93
800x2600	EPSBSD080260	EPSBSS080260	€ 981,19
800x2700	EPSBSD080270	EPSBSS080270	€ 1.162,64
900x2200	EPSBSD090220	EPSBSS090220	€ 703,06
900x2300	EPSBSD090230	EPSBSS090230	€ 703,06
900x2500	EPSBSD090250	EPSBSS090250	€ 957,80
900x2600	EPSBSD090260	EPSBSS090260	€ 1.075,08
900x2700	EPSBSD090270	EPSBSS090270	€ 1.239,36
1000x2200	EPSBSD100220	EPSBSS100220	€ 743,94
1000x2300	EPSBSD100230	EPSBSS100230	€ 743,94
1000x2500	EPSBSD100250	EPSBSS100250	€ 1.011,47
1000x2600	EPSBSD100260	EPSBSS100260	€ 1.143,90
1000x2700	EPSBSD100270	EPSBSS100270	€ 1.471,32

▶ METAL WARE (MAGNETIC LOCK, HINGES AND DOOR SEAL) IS NOT INCLUDED; SEE PAGE 14

▶ N° PACKAGES: 1

▶ DELIVERY TIME: 30 working days

▶ PRODUCTION WITH INTERVALS EVERY 50 MM (FOR PRICES SEE SUPERIOR SIZE); E.G.: A FRAME WITH PASSAGE SIZE MM 650X2500 WILL HAVE THE PRICE OF A MM 700X2500 FRAME

▶ FOR HEIGHT DIMENSIONS BETWEEN MM 1800 AND MM 1950 REQUEST A PREVENTIVE

ALL PRICES DO NOT INCLUDE TAX

SYNTESIS® LINE

battente - **HARDWARE**

Hardware includes a door seal, a magnetic lock, a strike plate, 3 hinges, 3 covers for door hinge and a screw bag.



HARDWARE



Door seal SCHLEGEL AQUAMAC 9111, length 6,6 m, to be cut to reqd. length



Magnetic lock



Eccentric strike plate



Cover for door hinge



Hinges



Screw bag

CODE	ITEM	PRICE
OPFER48	HARDWARE WITH LOCK KIT FOR HANDLE WITH OR WITHOUT KEY	€ 169,06
OPFER49	HARDWARE WITH LOCK KIT FOR HANDLE WITH TURN KNOB	€ 169,06

▶ WHEN THE DOOR WEIGHS MORE THAN 50 kg (max 65 kg) 4 HINGES ARE NEEDED (increase € 60,00)

▶ N° PACKAGES: 1

▶ DELIVERY TIME: 10 working days







ALL PRICES DO NOT INCLUDE TAX

SYNTESIS® LINE

battente - HANDLES



CASSIOPEA HANDLES

HANDLE		HANDLE WITH KEY		HANDLE WITH TURN KNOB	
					
					
CHROME SATINATED FINISHING					
CODE	PRICE	CODE	PRICE	CODE	PRICE
OSM2	€ 175,27	OSM4	€ 175,27	OSM6	€ 200,30

▶ N° PACKAGES: 1

▶ DELIVERY TIME: 20 working days

ALL PRICES DO NOT INCLUDE TAX



Total integration with the wall: the construction details are designed to ensure the perfect adhesion of the finishing material. The frame becomes one with the wall.
There is, but you do not see it.

Aesthetics

The typical structural strength of Eclisse frames is increased to avoid any change along the line of the door hole and to meet the request of non-standard dimensions.

Strength

Eclisse has always studied every detail of its products, for proving them easy to install and long-lasting.
Only the best ideas become projects that turn into benefits!

Ease of installation



ECLISSE s.r.l.

Via Sernaglia, 76 - 31053 Pieve di Soligo TV
Tel. 0039 0438 980 513 - Fax 0039 0438 980 804
international.sales@eclisse.it - www.eclisseworld.com

07/2013 © ECLISSE, all rights reserved.-The use, filing and total or partial reproduction, using any mechanical or electronic means, of texts, drawings and pictures contained in this publication is strictly prohibited, unless specifically approved in writing by ECLISSE. 602001600