

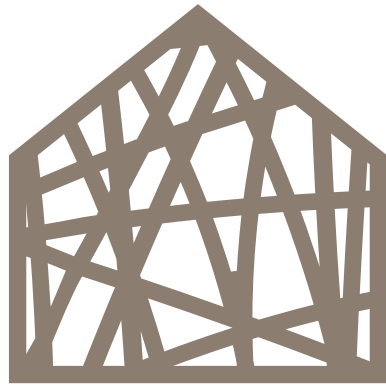

CELENIT
NATURAL INSULATORS

ACOUSTIC | DESIGN
TECHNICAL GUIDE



ACOUSTIC | DESIGN

Index

CONCEPT	4
----------------	---

ADVANTAGES	8
-------------------	---

SOLUTIONS

Sport	10
Education	12
Restaurants	14
Commercial	16
Public	18
Industry	20

APPLICATIONS

Customization	22
False ceilings	24
Wall coverings	26
Baffles and rafts	28
Design solutions	30

PRODUCTS

Our ranges	32
CELENIT ACOUSTIC range	33
CELENIT NB	33
CELENIT AB	34
CELENIT ABE	35
CELENIT ACOUSTIC FIRE range	36
CELENIT ACOUSTIC A2 range	37
CELENIT ACOUSTIC MINERAL range	38
CELENIT ACOUSTIC MINERAL A2 range	39
CELENIT BAFFLE range	40
BAFFLE SMART	40
BAFFLE BASIC	41
CELENIT DESIGN SOLUTIONS range	42
GROOVE	42
LEGNOMURO	43
SHAPES	43

EDGES	44
--------------	----

COLORS	45
---------------	----

CERTIFICATES

Sound absorption	46
Impact resistance	50
Fire resistance	51

SUSTAINABILITY	52
-----------------------	----

ABOUT US	54
-----------------	----



**The ACOUSTIC | DESIGN division
by CELENIT provides high
performance acoustic solutions:
environmentally friendly panels,
made of mineralized wood wool
that combine sound absorption
with indoor comfort and safety,
leading to an infinite range of
design options.**

What is CELENIT

Mineralised fir wood wool, bound with Portland cement. CELENIT boards are made of **wood wool** and mineral binders, mainly **Portland cement** and **marble dust**.



Fibres are mineralised: the process stops the biological deterioration, making the fibres totally inert. In addition to retaining wood's mechanical properties, it increases the level of resistance. Fibres are coated with Portland cement and bound together under pressure to form a **steady, resistant, compact** and **durable structure**.



The characteristics of CELENIT panels, such as mass, porous structure, low elastic modulus and internal absorption effect, make them very suitable to reduce background noise (**sound absorption**) and to shield sound transmissions (**sound insulation**).

CELENIT ACOUSTIC | DESIGN provides a range of advanced solutions that combine high **sound absorption** performance with the **sustainability** and eco-compatibility of a natural product, which is both aesthetically attractive and mechanically **resistant**.

Porosity and elasticity for high sound absorption.

In the picture below, fibres taken from a CELENIT panel are viewed under an electron microscope. It shows a perfectly conserved and efficient structure that explains the high degree of the product resistance and stability. Its insulating characteristics are enhanced by the presence of the mineral binder not affecting the wood fibres, but protecting them.

CELENIT boards can be classified as natural sound absorbers. They dissipate sound through their cellular structure by a progressive reduction of the energy, that is converted into heat.

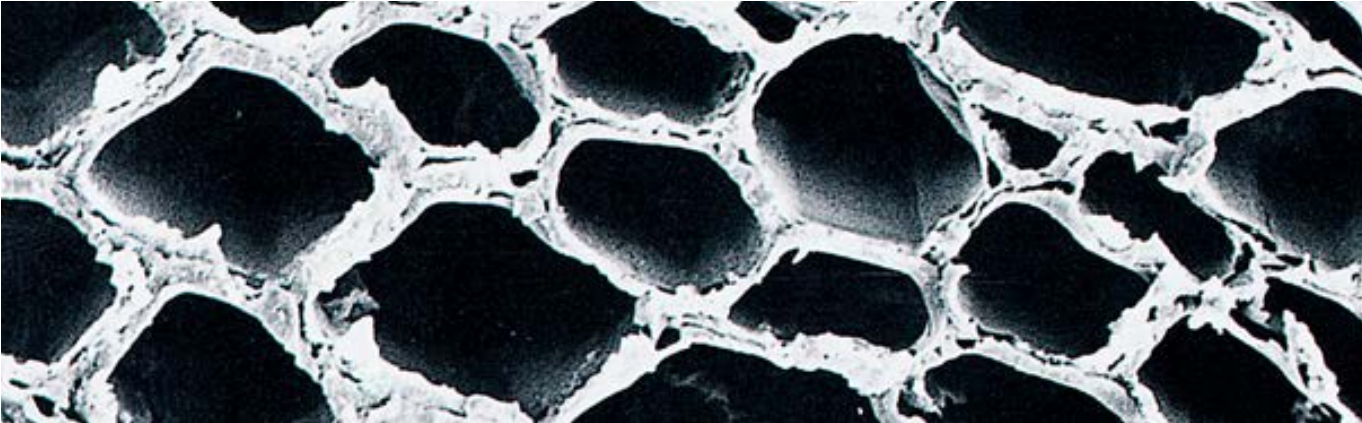

Acoustic comfort and aesthetic pleasure

An accurate acoustic design of crowded public places such as restaurants, schools, theatres, conference halls and cinemas needs a consistent choice of products, with already tested and certified performance

Interior designers do not often consider acoustic insulation issues when designing buildings. In fact, crowded public places are often rich in smooth uncoated surfaces, which have a strong reverberation and amplify any noise.

Bar and restaurant owners often underestimate the importance of acoustically insulating their premises. In reality, excessive background noise can annoy customers who tend not to come back, as well as lowering the staff's productivity and concentration, while increasing their stress as they are forced to work for hours in an acoustically uncomfortable environment.

Instead, adequate sound comfort must be guaranteed schools, as required by law, in order to improve people's understanding and the safety of coverings that are able to stand up to impact and support possible accidental loads from the collapse of slabs in hollow-core concrete flooring systems in the case of existing buildings.

With the ACOUSTIC | DESIGN products line, **CELENIT** provides advanced solutions that blend high sound absorption performance with the sustainability and eco-compatibility of a natural product, which is also aesthetically attractive and mechanically resistant. With their particular surface configuration, wood wool boards are natural sound absorbers. Soundwaves do not bounce from one wall to another, rather they are partly absorbed and dissipated, thus avoiding annoying reverberation.

CELENIT boards, with their various textures and colorations, manufactured edges and several mounting systems, allow creating innovative ideas with an attractive design to generate positive visual sensations. These precise solutions range from an entire surface to prompt interventions for working in existing environments. In fact, the fast and versatile application of **CELENIT** panels permits requalifying environments with serious problems of reverberation without sacrificing the opening hours of restaurants, bars and public places, as work can be done quickly when they are closed in the summer or in winter in the case of schools.

Thanks to a broad range of tests and research, **CELENIT** has implemented the exposed covering systems and provides documentation indicating the sound absorption values for the three categories of products: wood wool boards (CELENIT ACOUSTIC and CELENIT ACOUSTIC A2 ranges, CELENIT BAFFLE), composite wood wool boards with rock wool (CELENIT ACOUSTIC MINERAL and CELENIT ACOUSTIC MINERAL A2 ranges) and composite wood wool boards with fire resistant plasterboard (CELENIT ACOUSTIC FIRE).



CATERINA CUCINA & FARINA Milano, IT
design: Maja Group | photo: Ilaria Caprifoglio

Advantages

ACOUSTIC | DESIGN products are excellent acoustic insulation boards with high insulation performance and they allow the creation of safe sustainable spaces with innovative design.



Sound absorption

Porosity and elasticity for a high sound absorption.

CELENIT boards can be classified as natural sound absorbers. They dissipate sound energy through their cellular structure by progressively reducing energy, which is converted into heat. They have a good level of sound absorption especially at higher frequencies (acute tones), which are the more common ones. CELENIT panel absorption increases with thickness and when coupled with a layer of mineral wool. Research has allowed us to make a large database of sound absorption certificates available to the designer.

Tests were carried out at the laboratories of Giordano Institute using three main application methods - adherence, empty air gap and background filled with mineral wool or wood fiber - as well as using different product ranges, varying textures, thicknesses, and lowering.



Sustainability and eco-compatibility

Certified boards by ANAB-ICEA and natureplus for the sustainability of the product and the production process.

The raw materials that compose eco-friendly CELENIT boards are: wood from sustainably managed forests (PEFC™ or FSC® certificate); Portland cement and calcium carbonate residue of marble to form the percentage of recycled material (ICEA certificate). Products and their components are not dangerous to human health and the environment. The production process has low resource consumption and low emissions.



Indoor comfort

CELENIT false ceilings and coverings ensure well-being through naturalness.

Wood wool boards favor users being in especially crowded buildings. They are eco-friendly, certified by ANAB-ICEA and natureplus, which ensure not causing harm to individuals' health; they are tested to be free from critical emissions of carcinogens, formaldehyde, volatile organic compounds VOC and asbestos, according to EN 13964 standard.



Fire protection

Planning that ensures the safety of users in case of fire is crucial.

In crowded public places, fire safety must be designed very carefully in order to avoid risk to people's lives and damage to the goods. Wood wool panels are classified in reaction to fire A2-s1,d0 and B-s1,d0. Furthermore, the fire resistance values of false ceilings can reach 60 minutes of fire resistance (EI60 certificate), maintaining its aesthetic appearance and acoustic qualities.



Flexible design

CELENIT recommends versatility and flexibility as the passwords for creativity!

Wood wool boards can be used for countless creative solutions. Baffles applications, curved finishing, furnishings, special patterns, shelves and cubes. The simplicity of the boards allows creating attractive shapes with an innovative design. CELENIT panels are exceptionally versatile with high aesthetic value, able to meet all designers' modern expectations.



Accidental ceiling drop safety

Compactness and mechanical strength for safe and certified design.

Thanks to the hardness and the mechanical resistance of wood wool panels, CELENIT provides certified solutions to guarantee the safety of the people under CELENIT false ceilings when there is the risk of dangerous material falling, especially from old ceilings. This is ensured by retaining all the natural and aesthetical features of ACOUSTIC | DESIGN products. CELENIT boards can be easily removed if an inspection of the ceiling is required to check its safety over the time.



Customized design solutions

Designers can define their own interior design line with wood wool coverings.

For designers who are looking for new and original ideas to express their creativity, CELENIT offers products with features that enhance the aesthetic finish. From pose type to manufactured edges, from textures to the different colorations available, designers have a lot of creative ideas to shape their own architectural projects, customizing interior design by enhancing aesthetic features.



Impact resistance and balls

Impact resistance is essential in sports facilities.

CELENIT has certified solutions for false ceilings and wall coverings that are resistant to being hit by balls. This feature is very important to guarantee the stability of covering systems. The resistance of the boards has been tested by Giordano Institute, according to EN 13964 and DIN 18032-3, obtaining the A1 class resistance, which is highest attainable.



Thermal and acoustic insulation

CELENIT wood wool false ceilings and coverings for total insulation.

CELENIT solutions for acoustic coverings improve winter thermal insulation and thermal inertia of the buildings. In addition, CELENIT offers a wide range of solutions for acoustic insulation with sound insulating power certified for partitions, perimeter walls and lightweight roofs. These certifications are essential to correctly assess the acoustic insulation of the façade.

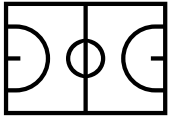

SPORT

Facilities for recreational activities, free time, sports and fitness require robust, durable and safe sound absorbing surfaces, which ensure the safety of users and aesthetics. CELENIT has certificated solutions to guarantee a long life and appealing design, with high performance and resistant products.

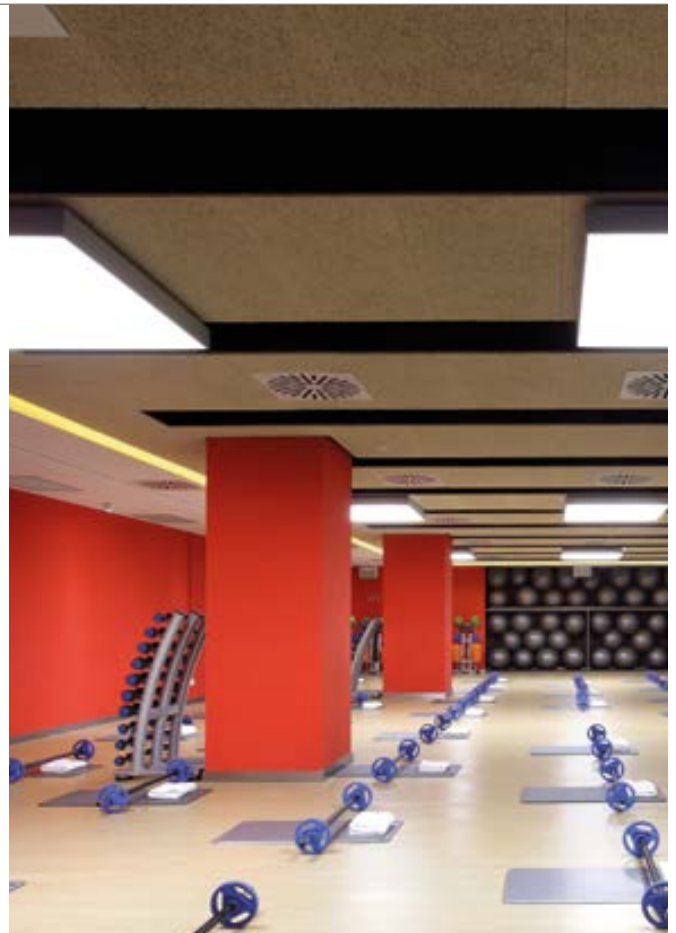

CLUB METROPOLITAN Bilbao, ES
design: B+R Arquitectos | photo: Roberto Lara Fotografía



CADORAGO SPORTS HALL Como, IT
design: Marco Castelletti architetto | photo: Filippo Simonetti



VITTORIA COLONNA INSTITUTE Milano, IT
design: Studio ARX2 architects Giancarlo Noce + Giovanni Picolli + Angela Natale | photo: Daniele Frigerio



EDUCATION

CELENIT, with over than 50 years of experience in acoustic and thermal insulation, provides maximum comfort solutions for school refurbishing for ensure maximum quality, durability, certified acoustic comfort, safety for pupils' health and environment sustainability.



CITTADELLA PRIMARY SCHOOL Padova, IT
design: Gianni Toffanello architetto | photo: Giovanni Porcellato



RALDON SCHOOL Verona, IT
design: Michael Tribus Architecture | photo: Meraner & Hauser



AMATORI INSTITUTE Vicenza, IT
design: Caretta Carlo e Depau Liliana architetti | photo: Giovanni Porcellato



RESTAURANTS

Excessive noise is often overlooked by owners of bars and restaurants. CELENIT offers acoustic solutions for interior design that ensure comfort to customers and staff, creating a more relaxed and pleasurable environment that improves business productivity.



SPAZIO CAFFELARTE Treviso, IT
design: Dario Maggiolo architetto | photo: Nicoletta Aveni



IT'SO NATURAL! Milano, IT
design: Maja Group | photo: Ilaria Caprifoglio



TINGLADO Pamplona, ES
design: Koa Arquitectura | photo: Koa Arquitectura



COMMERCIAL

Creative design solutions, simple yet customized with versatile interior design systems, which meet the acoustic needs of offices, stores and other businesses.



BESTWAY EUROPE SRL Milano, IT
design: Sara Signorini Architetto | photo: Sara Signorini Architetto



EQUIPE SADDLERY Vicenza, IT
design: Verlatto+Zordan architetti associati | photo: Giovanni Porcellato



LA STAZIONE Conegliano, IT
design: Francesco Dal Col architetto | photo: Studioarchitettura Dal Col & Pisotti



PUBLIC

Public spaces for the community and the gathering of people where persist reverberation problems and difficulties of speech intelligibility, need design solutions that integrate acoustic comfort, indoor wellness and a customizable design.



VÅRDBOENDE TRÄDGÅRDARNA, ELDERLY CENTRE Örebro, SE
design: Marge Arkitekter | photo: Johan Fowellin



ONLUS MARTINO SANESI PAVILION Sondrio, IT
design: act_romejalli + Luca Volpatti architetto | photo: Marcello Mariana



INTERBRENNERO CONFERENCE CENTRE Trento, IT
design: Mauro Facchini architetto | photo: Alessia Mora

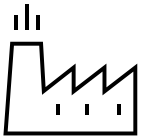

INDUSTRY

In factories and other industrial buildings solutions with CELENIT sound absorbing panels provide very good acoustic comfort, protecting the workers from loud noise and reflecting light well. All this creates good work environments.

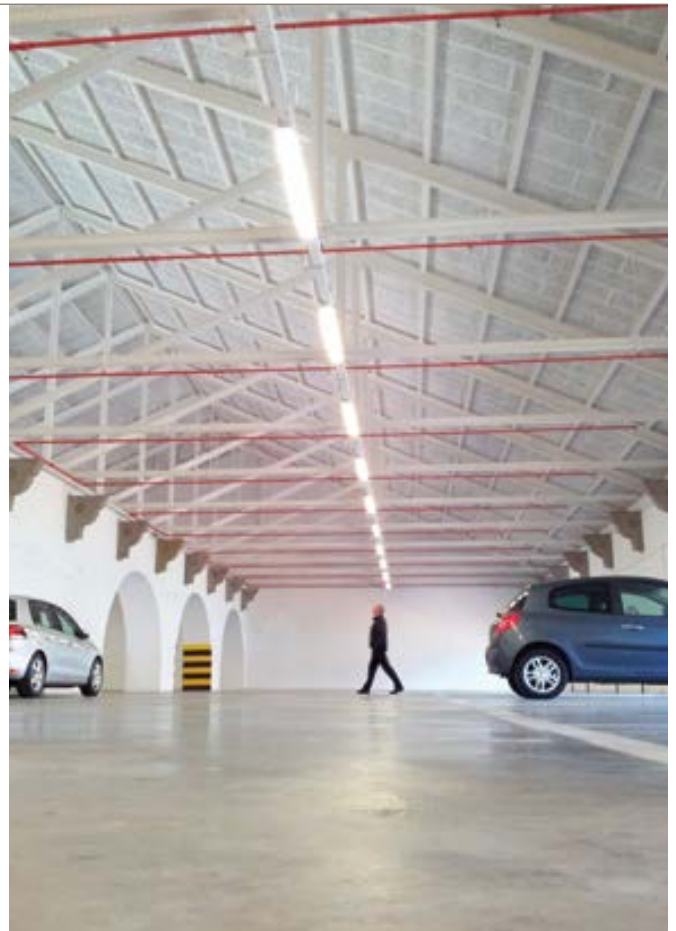

SILOS PARKING Trieste, IT
photo: Eddy Tiozzo



WORKSHOP Roma, IT
photo: Alessia Mora

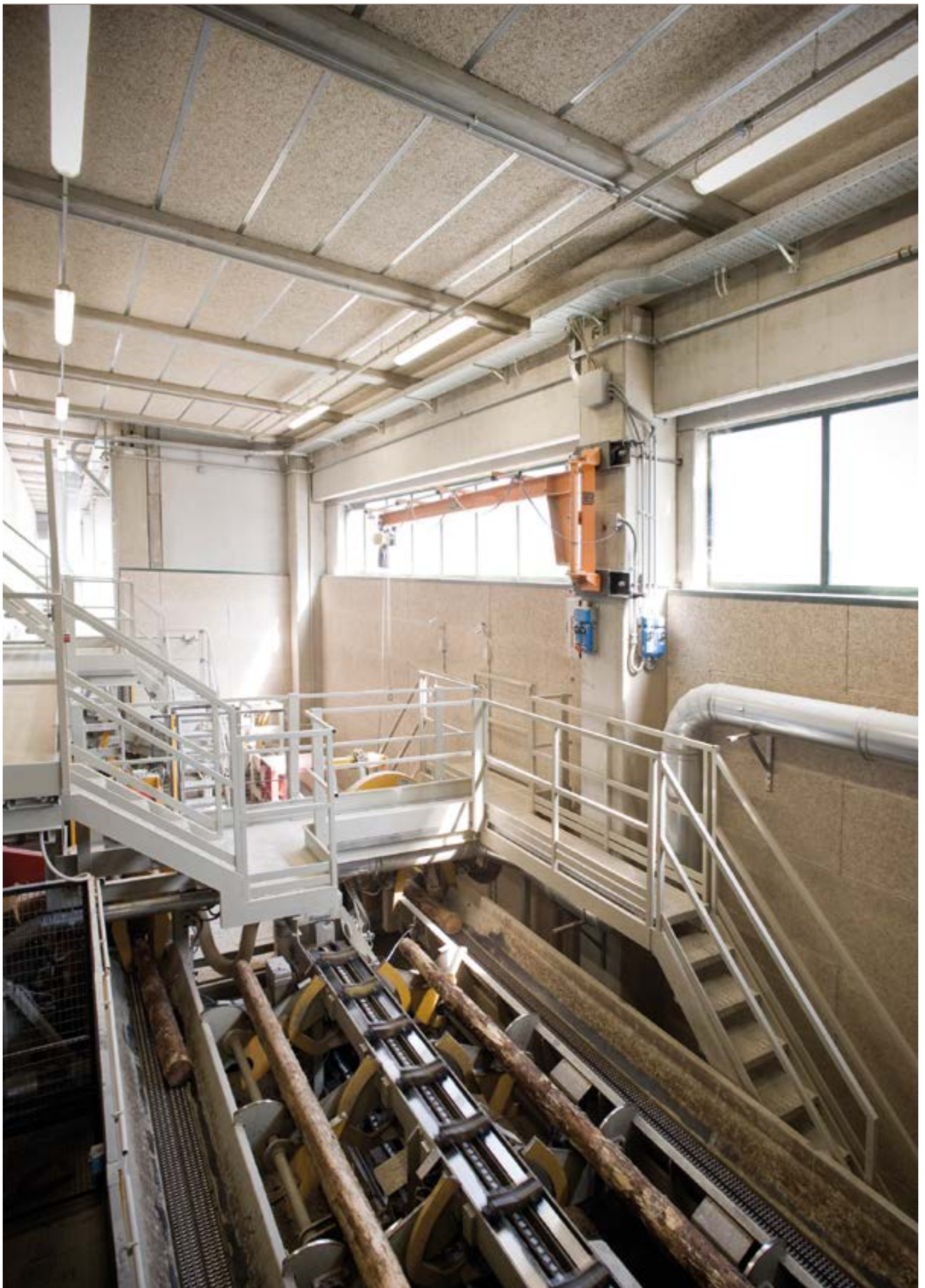

CELENIT HEADQUARTERS Padova, IT
design: Piero Svegliado architetto | photo: Giovanni Porcellato

Customization

The covering solution can be configured by choosing the type of application and the product according to the following characteristics.

APPLICATION

Sound-absorbing coverings can be applied as continuous structures (false ceilings and wall coverings) or they can be installed as punctual elements and repeatable modules in applications such as baffles, rafts or design elements.



False ceilings



Wall coverings



Baffles and rafts



Design solutions

TEXTURES

CELENIT ACOUSTIC | DESIGN products are available in three textures, which differ in the width of the wood wool.



Extra-thin texture
1 mm



Thin texture
2 mm



Standard texture
3 mm

THICKNESS

Wood wool boards are available in 4 thicknesses (15, 25, 35, 50 mm). Composite panels with mineral wool are made with layers of wood wool in the thicknesses: 7, 10, 15, 25, 35 mm.



15 mm



25 mm



35 mm



50 mm

DIMENSIONS

Boards are 60 cm wide and 60-120-200-240 cm long. They can be easily cut into customized shapes, following the designer's creativity.

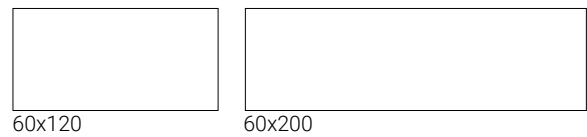
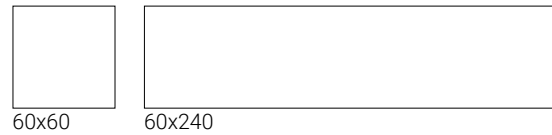

EDGES

CELENIT provides a range of different edges that are thought to allow correct installation for each kind of finish.

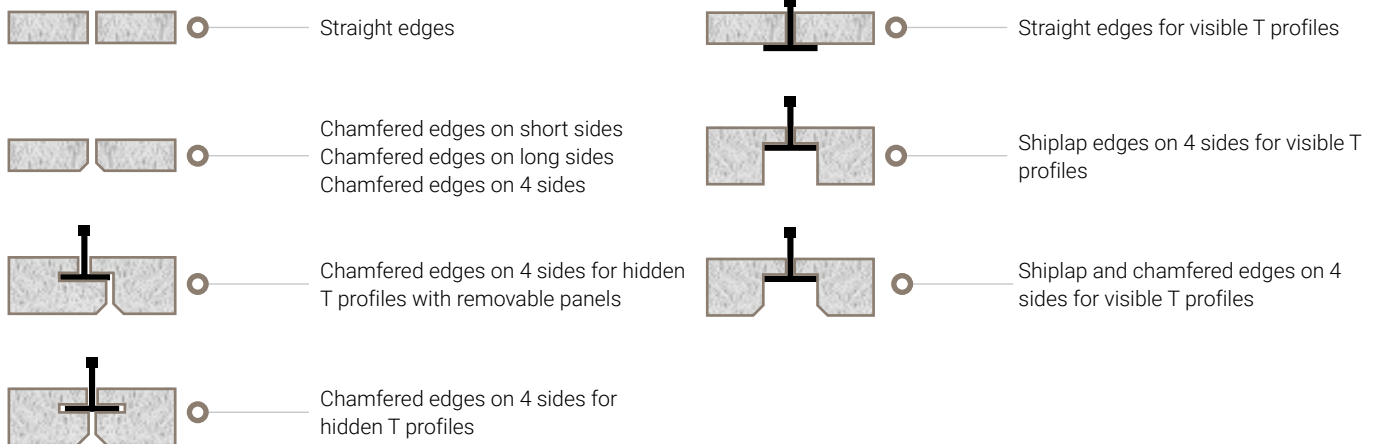

COLORS

Panels can be bare, in the NATURE version (the natural ivory colour of the mineralised fibre), or they can be coloured. Painting guarantees the chromatic uniformity of the covering.

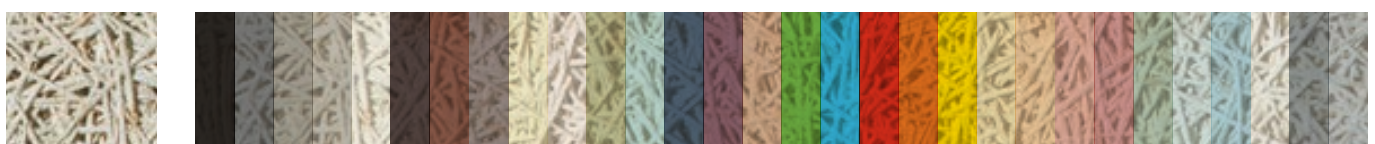

NATURE

CELENIT color ranges



FALSE CEILINGS

False ceilings for a high-level design.



False ceilings with visible structure

This system is simple and traditional, it is perfectly suited to upgrading works and accentuates the shape and the false ceiling structure by emphasizing T or Omega metal profiles. Lowered edges (RD or RS code) partially hide the structure, creating lighting effects and very interesting shadows. This system allows easy access to installations behind them.

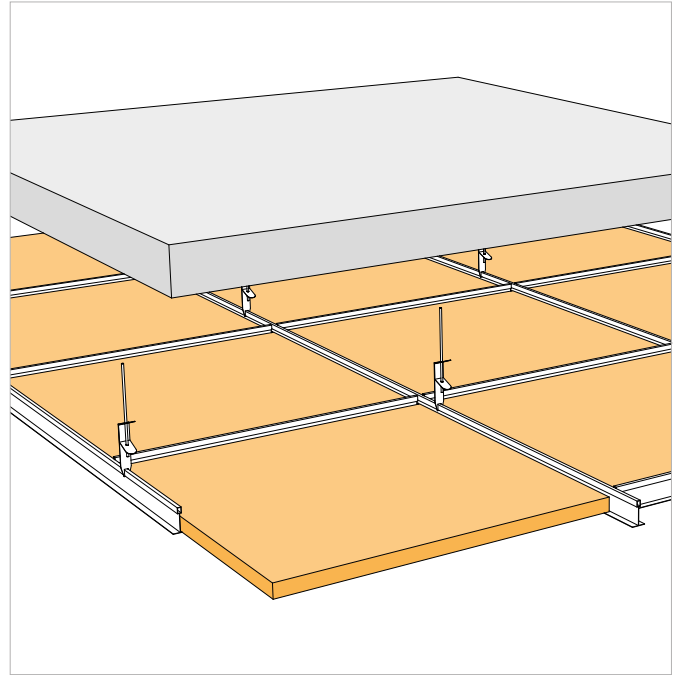
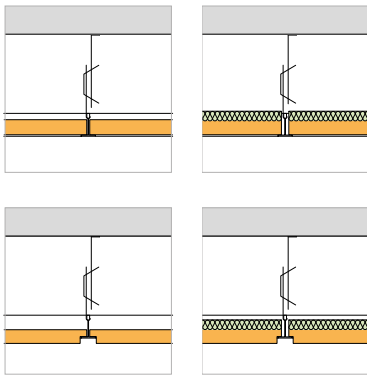

Installation on hidden T profile

The boards with special edges (PM or PS code) are placed into T metal profiles, which cover the structure, creating a continuous ceiling surface.

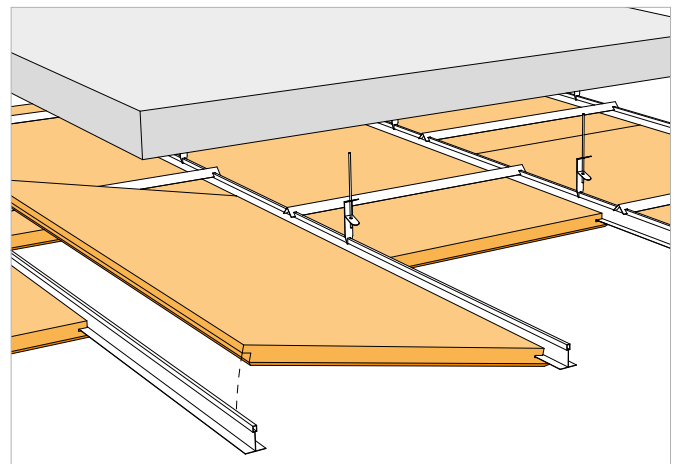
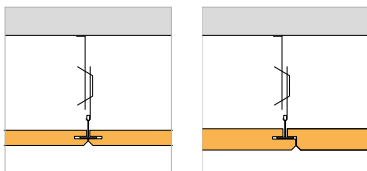

Installation on hidden structure

CELENIT panels can be directly screwed onto wooden laths or a C metal profile. Boards can also be fastened with screws to the ceiling.

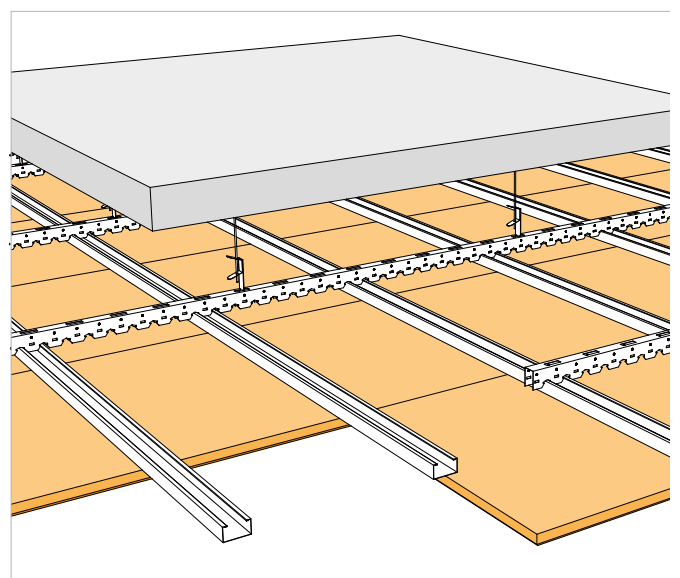
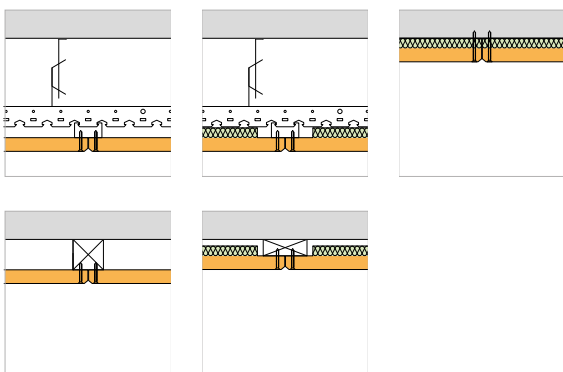



WALL COVERINGS

Coverings with high sound absorption performance for large areas or limited portions of walls.



Installation on hidden structure

CELENIT panels can be directly screwed onto wooden laths or a C metal profile. Boards can also be fastened with screws to the wall.

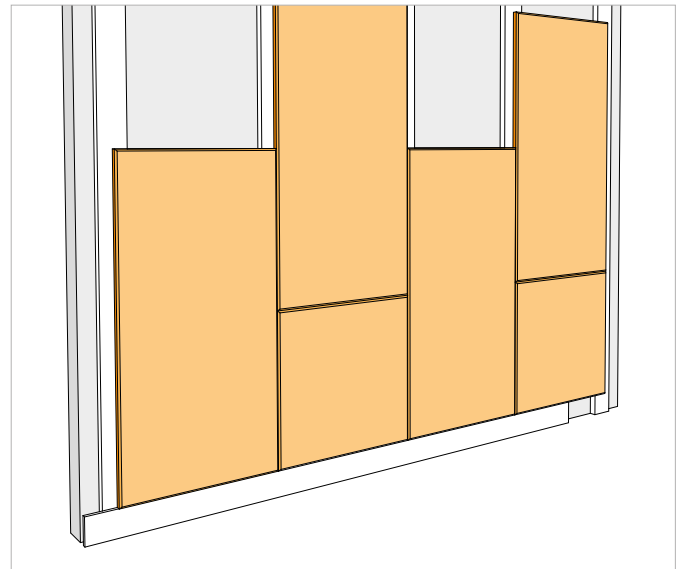
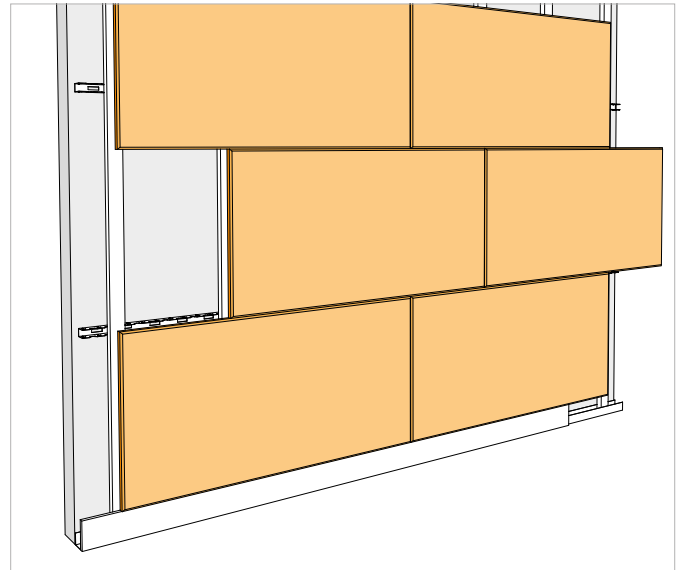
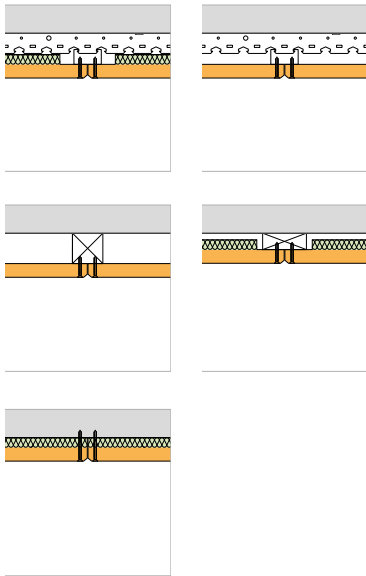

Wall coverings with visible structure

This solution is designed for big spaces where a false wall with an air-gap behind the sound absorbing surface is not required. Wood wool panels are retained by Omega profiles placed vertically and fastened directly to the wall with appropriate fixing devices. The boards can also be fastened to a hidden structure, with Omega profiles then placed vertically or horizontally.

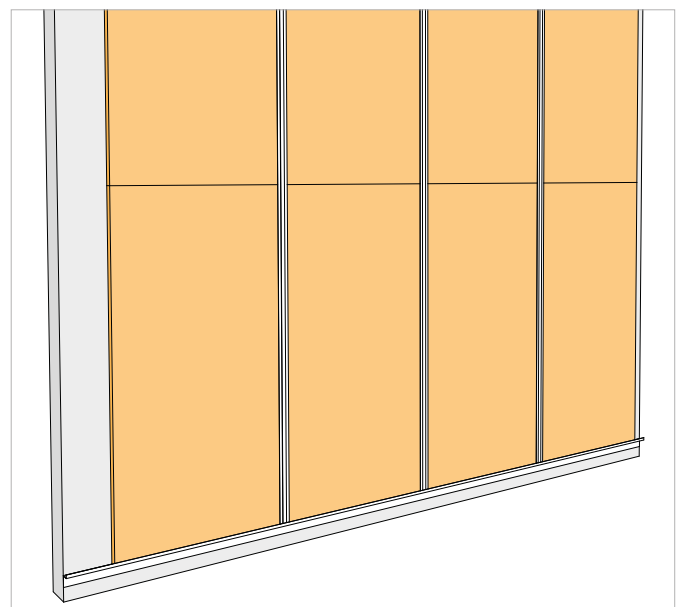
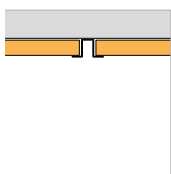



BAFFLES AND RAFTS

A creative approach for versatile and attractive solutions!



Baffles

Acoustic corrections for places where it is not possible to install an entire false ceiling. The application of baffles is the ideal option for acoustic correction due to the wide sound absorbing surface provided by the vertical elements.

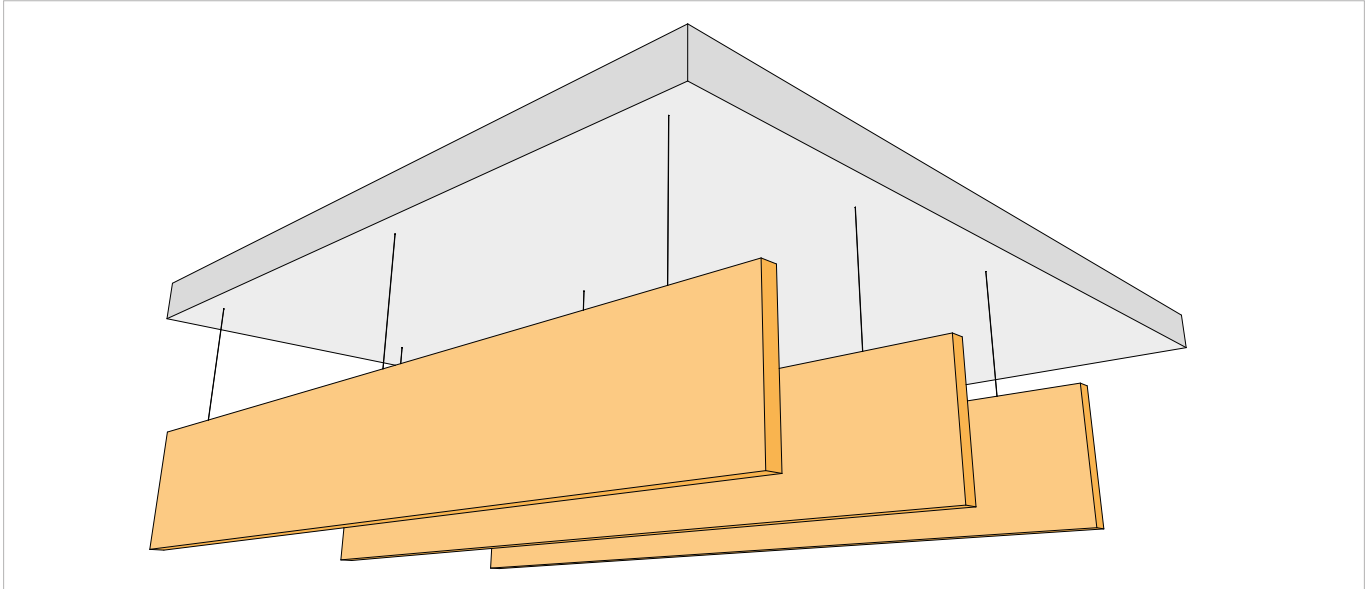

Rafts

An innovative application for specific acoustic corrections designed for wide spaces with sound sources and receivers, where covering the entire ceiling surface is not necessary. It improves the acoustic comfort of the place by giving particular expression to design.

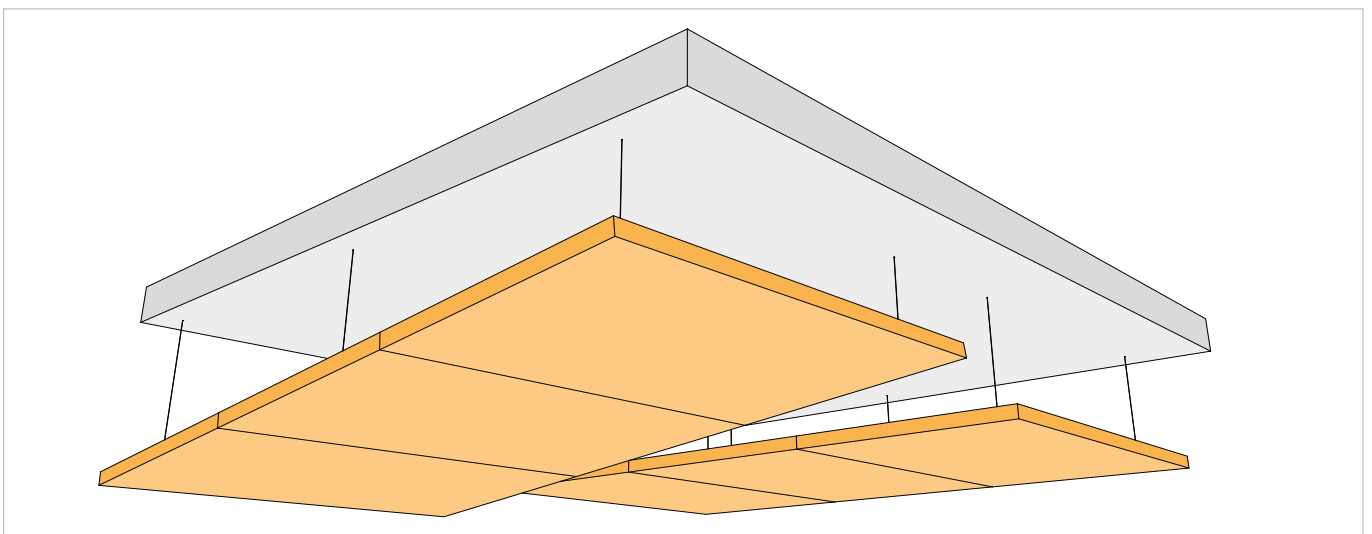



DESIGN SOLUTIONS

Walls and ceilings, combinations of colors and different sizes, matching of thicknesses and textures, mosaics and interior design.



Compositions and overlays

You can create 3D effects by combining and overlaying panels with different thicknesses. Boards can also be easily cut, creating patterns with tones and different color shades for a unique design creation.

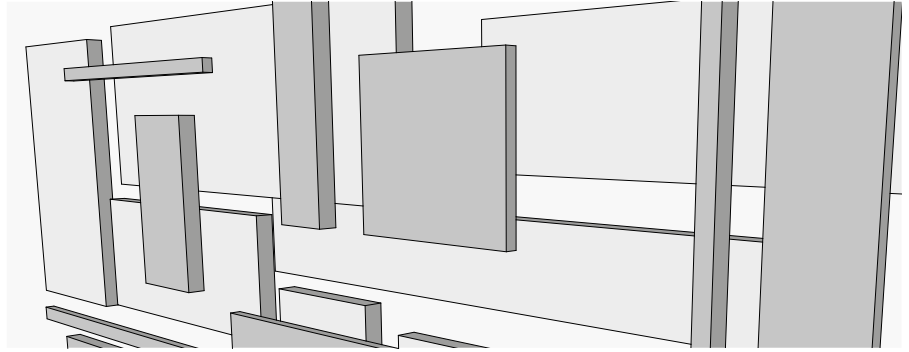

Shapes

Wood wool panels can be easily cut in the desired shapes.
Bards dimensions:
- width 60 cm
- length 60 - 120 - 200 - 240 cm.

LEGNOMURO is a sound absorbing element 29x29 cm, thickness 25 mm with chamfered edges. It is useful for flexible design solutions on walls.

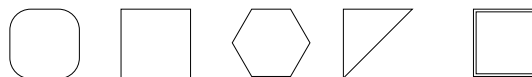

Surface patterns

Panels with extra thin or thin texture can be supplied with this surface patterns consisting of parallel milling that creates plays of light and shadows, creating a particular three-dimensional effect.

GROOVE is a wood wool panel with thin or extra-thin texture with parallel milling on the long side. It is used for continuous wall or false ceiling applications.



Our ranges

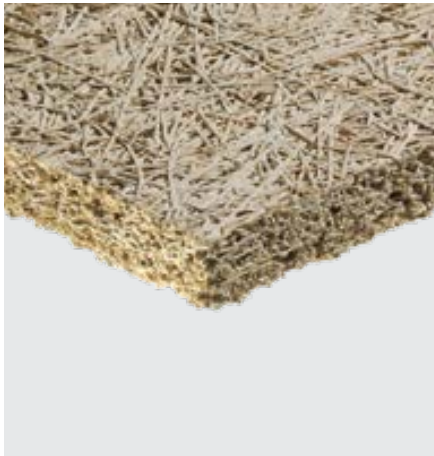

CELENIT ACOUSTIC

Boards made of mineralized wood wool bound with white Portland cement

Products: **ABE - AB - NB**



CELENIT ACOUSTIC FIRE

Boards made of mineralized wood wool bound with white Portland cement coupled to a layer of plasterboard type F

Products: **AB/F**



CELENIT ACOUSTIC A2

Boards in Euroclass A2-s1, d0 made of mineralized wood wool bound with white Portland cement and mineral powder

Products: **ABE/A2 - AB/A2**



CELENIT ACOUSTIC MINERAL

Boards made of mineralized wood wool bound with white Portland cement coupled to a layer of rock wool

Products: **L2ABE15 - L2AB15
L2ABE25 - L2AB25
L2ABE35 - L2AB35
L2ABE25C
L3ABE**



CELENIT ACOUSTIC MINERAL A2

Boards in Euroclass A2-s1, d0 made of mineralized wood wool bound with white Portland cement and mineral powder coupled to a layer of rock wool

Products: **L2ABE15/A2 - L2AB15/A2
L2ABE25/A2 - L2AB25/A2
L2ABE25C/A2
L3ABE/A2**

CELENIT BAFFLE

Vertical sound absorbing elements consists of CELENIT wood wool panels

Products: **BAFFLE SMART
BAFFLE BASIC**

CELENIT DESIGN SOLUTIONS

Complete systems for innovative design coverings. Ceiling and wall applications and surface finishing of the boards.

Products: **GROOVE
LEGNOMURO
SHAPES**

Range

CELENIT ACOUSTIC

CELENIT NB

Thermal and acoustic insulation board, consisting of mineralized fir wood wool bound with white Portland cement. Wood wool is 3 mm wide. It complies with EN 13168 and EN 13964 standards.

CELENIT ACOUSTIC product range with **standard texture**. It has significant sound absorption properties, thermal insulation and thermal inertia, fire protection, moisture resistance, impact resistance, durability and naturalness.

In addition to wall and ceiling coverings, **CELENIT NB** is also used as permanent formwork with visible finishing.



Applications



False ceilings, wall coverings, baffles and rafts, design solutions.

Systems

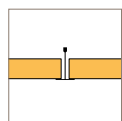

False ceilings on visible T24 profiles
Edge code: **DT - T**

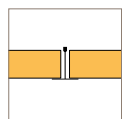

False ceilings on visible T35 profiles
Edge code: **DT - T**

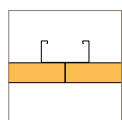

False ceilings and wall coverings with metal or wood hidden structure
Edge code: **D**

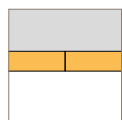

Application in adherence to the ceiling/wall
Edge code: **D**

Technical data

Dimensions

2400x600 - 2000x600 - 1200x600 - 600x600 mm

Thickness

15 - 25 - 35 - 50 mm

Reaction to fire

Euroclass B-s1, d0

Environmental certifications

PEFC™ or FSC® certified product
natureplus - ecocompatibility
ANAB-ICEA - Eco-building materials
EPD - environmental statement
ICEA - recycled material
ICEA - LEED credits attestation

PRODUCTS

Range

CELENIT ACOUSTIC

CELENIT AB

Thermal and acoustic insulation board, consisting of mineralized thin fir wood wool bound with white Portland cement. Wood wool is 2 mm wide. It complies with EN 13168 and EN 13964 standards.

Thanks to its **thin texture** and unique compactness, toughness and mechanical strength, **CELENIT AB** is the perfect material for a **highly aesthetic sound-absorbing finish**, with optimal reaction to fire, impact resistance and unalterability in contact with moisture.

It is the wood wool panel with excellent sound absorption performance, with certified **α_w values up to 0.95**.



Applications



False ceilings, wall coverings, baffles and rafts, design solutions

Systems

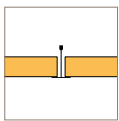

False ceilings on visible T24 profiles
Edge code: **DT - T - RDT - RST**

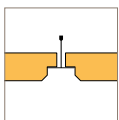

False ceilings on visible T35 profiles
Edge code: **DT - T - RDT35 - RST35**

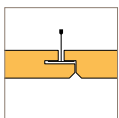

False ceilings on hidden T35 profiles
Edge code: **PS - PM**

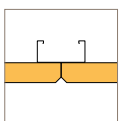

False ceilings and wall coverings with metal or wood hidden structure
Edge code: **D - S4 - RD**

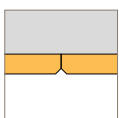

Application in adherence to the ceiling/wall
Edge code: **D - S4**

Technical data

Dimensions

2400x600 - 2000x600 - 1200x600 - 600x600 mm

Thickness

15 - 25 - 35 - 50 mm

Reaction to fire

Euroclass B-s1, d0

Sound absorption

- 1. Application in adherence - **α_w up to 0.60**
- 2. Empty air-gap - **α_w up to 0.65**
- 3. Background filling with rock wool - **α_w up to 0.95**

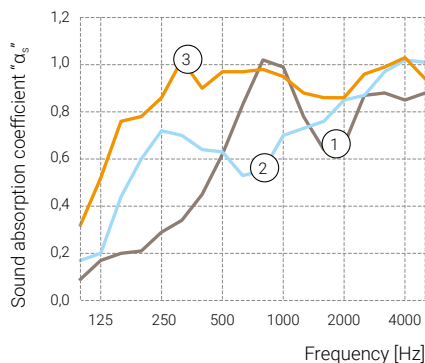

Environmental certifications

- PEFC™ or FSC® certified product
- natureplus - ecocompatibility
- ANAB-ICEA - Eco-building materials
- EPD - environmental statement
- ICEA - recycled material
- ICEA - LEED credits attestation

Range

CELENIT ACOUSTIC

CELENIT ABE

Thermal and acoustic insulation board, consisting of mineralized extra-thin fir wood wool bound with white Portland cement. Wood wool is 1 mm wide. It complies with EN 13168 and EN 13964 standards .

Thanks to its **extra-thin texture** and unique compactness, toughness and mechanical strength, **CELENIT ABE** is the perfect material for a **highly aesthetic sound-absorbing finish**, with optimal reaction to fire, impact resistance and unalterability in contact with moisture.

It is the wood wool panel with the best sound absorption performance, with certified α_w values up to **1.00**.



Applications



False ceilings, wall coverings, baffles and rafts, design solutions

Systems

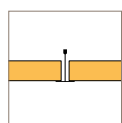

False ceilings on visible T35 profiles
Edge code: **DT - T - RDT - RST**

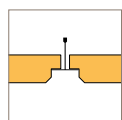

False ceilings on visible T35 profiles
Edge code: **DT - T - RDT35 - RST35**

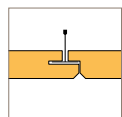

False ceilings on hidden T35 profiles
Edge code: **PS - PM**

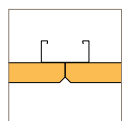

False ceilings and wall coverings with metal or wood hidden structure
Edge code: **D - S4 - RD**

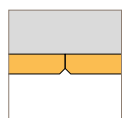

Application in adherence to the ceiling/wall
Edge code: **D - S4**

Technical data

Dimensions

2400x600 - 2000x600 - 1200x600 - 600x600 mm

Thickness

15 - 25 - 35 mm

Reaction to fire

Euroclass B-s1, d0

Sound absorption

1. Application in adherence - α_w up to **0.50**
2. Empty air-gap - α_w up to **0.70**
3. Background filling with rock wool - α_w up to **1.00**

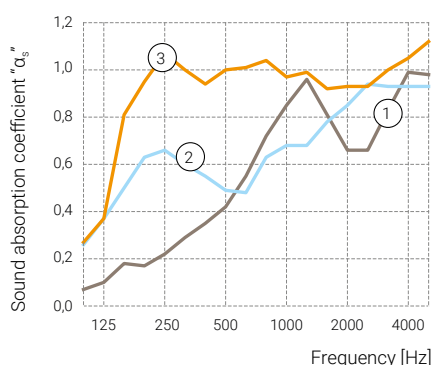

Environmental certifications

PEFC™ or FSC® certified product
natureplus - ecocompatibility
ANAB-ICEA - Eco-building materials
EPD - environmental statement
ICEA - recycled material
ICEA - LEED credits attestation

PRODUCTS

Range

CELENIT ACOUSTIC FIRE

CELENIT AB/F

Composite thermal and acoustic insulation board, EI 60 fire resistance, consisting of a layer of mineralized thin fir wood wool bound with white Portland cement in compliance with the EN 13168 standard, 25 mm thick, coupled to a layer of fire resistant plasterboard type F, in compliance with the EN 520 standard, 15 mm thick. Wood wool is 2 mm wide. It complies with the EN 13964 standard.

CELENIT ACOUSTIC FIRE is the **wood wool panel coupled to a fireproof plasterboard**, which achieves superior fire performance while maintaining all the aesthetic, eco-friendly, sound absorption and mechanical strength features. False ceilings with CELENIT AB/F are **certified EI 60 fire resistance**, allowing all fire problems to be solved, especially in public buildings and schools.



Applications



False ceilings

Systems

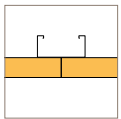

False ceilings with hidden metal structure
Edge code: **D**

Technical data

Dimensions

1200x600 mm

Thickness

40 (25/15) mm

Reaction to fire

Euroclass B-s1, d0

Sound absorption

Empty air-gap - α_w up to 0.35

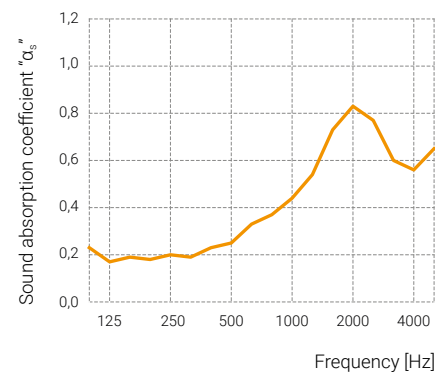

Environmental certifications

PEFC™ or FSC® certified product

Range

CELENIT ACOUSTIC A2

Thermal and acoustic insulation board in Euroclass A2-s1, d0 consisting of mineralized fir wood wool bound with white Portland cement and mineral powder. It complies with EN 13168 and EN 13964 standards.

CELENIT ACOUSTIC A2 product range consists of **wood wool panels that achieve superior fire performance.**

With the addition of mineral powder in the wood-concrete mixture, the panels attain the Euroclass A2-s1, d0, while maintaining aesthetic appearance and the excellent sound-absorption properties.

The best safety features from the attack of flames make these panels also suitable for visible applications where fire-safety requirements are stricter.



Applications



False ceilings, wall coverings, baffles and rafts, design solutions

Systems

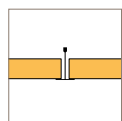

False ceilings on visible T24 profiles
Edge code: **DT - T - RDT - RST**

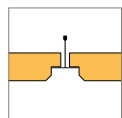

False ceilings on visible T35 profiles
Edge code: **DT - T - RDT35 - RST35**

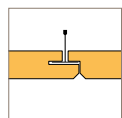

False ceilings on hidden T35 profiles
Edge code: **PS - PM**

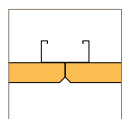

False ceilings and wall coverings with metal or wood hidden structure
Edge code: **D - S4 - RD**

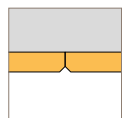

Application in adherence to the ceiling/wall
Edge code: **D - S4**

Technical data

Dimensions

2400x600 - 2000x600 - 1200x600 - 600x600 mm

Thickness

CELENIT ABE/A2
15 - 25 - 35 mm

CELENIT AB/A2

15 - 25 - 35 - 50 mm

Reaction to fire

Euroclass A2-s1, d0

Sound absorption

1. Application in adherence - α_w up to **0.45**
2. Empty air-gap - α_w up to **0.60**
3. Background filling with rock wool - α_w up to **1.00**

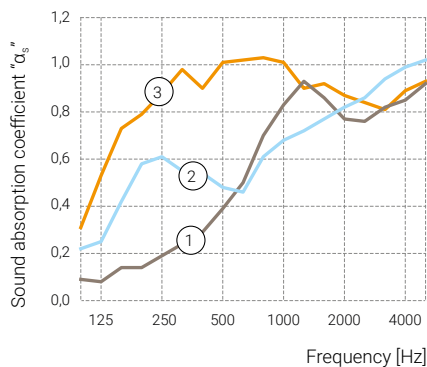

Environmental certifications

PEFC™ or FSC® certified product
ANAB-ICEA - Eco-building materials
ICEA - recycled material
ICEA - LEED credits attestation

PRODUCTS

Range

CELENIT ACOUSTIC MINERAL

Composite thermal and acoustic insulation board, consisting of one or two layers of mineralized fir wood wool bound with white Portland cement coupled to a layer of mineral wool according to the EN 13162 standard. It complies with EN 13168 and EN 13964 standards.

CELENIT MINERAL ACOUSTIC product range consists of composite wood wool panels that reach the **highest sound absorption performance**, even from low to high frequencies, with α_w values up to 1.00.

All panels differ in the thickness of the wood wool layer (15/25/35 mm), the wood wool width (extra thin 1 mm - thin 2 mm) and the type of rock wool.

L2ABE25C boards can be screwed directly onto the ceiling or wall or a hidden structure. L3ABE boards can be laid on visible structures or screwed directly onto the ceiling.

L2AB15, L2ABE15, L2AB25, L2ABE25, L2AB35, L2ABE35 boards are coupled to a layer of mineral wool with non woven glass fibre. They can be laid on visible structures or fixed to an hidden structure (with rock wool dimensions 1200x500).

Applications



False ceilings, wall coverings

Systems

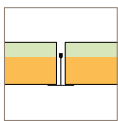

False ceilings on visible T35 profiles
CELENIT L2ABE15 - CELENIT L2AB15
Edge code: **DTL**

CELENIT L2ABE25 - CELENIT L2AB25
Edge code: **DTL-RDT-RSTL**

CELENIT L2ABE35 - CELENIT L2AB35
Edge code: **RDT-RSTL**

CELENIT L3ABE
Edge code: **DT - T**

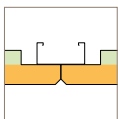

False ceilings and wall coverings with metal or wood hidden structure (rock wool 1200x500 mm)
CELENIT L2ABE25 - CELENIT L2AB25
CELENIT L2ABE35 - CELENIT L2AB35
Edge code: **D - S4**

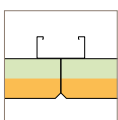

False ceilings and wall coverings with metal or wood hidden structure
CELENIT L2ABE25C - CELENIT L2AE25C
Edge code: **D - S4**

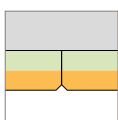

Application in adherence to the ceiling/wall
CELENIT L2ABE25C - CELENIT L3ABE
Edge code: **D - S4**



Technical data

Dimensions

1200x600 mm

Thickness

CELENIT L2ABE15 - CELENIT L2AB15
40(15/25) - 55(15/40) mm

CELENIT L2ABE25 - CELENIT L2AB25
43(25/18) - 50(25/25) - 65(25/40) mm

CELENIT L2ABE35 - CELENIT L2AB35
53(35/18) - 75(35/40) mm

CELENIT L2ABE25C
50(25/25) - 75(25/50) - 100(25/75) - 125(25/100) - 150(25/125) mm

CELENIT L3ABE
25(7/15/3) - 35(10/20/5) - 50(10/35/5) mm

Reaction to fire

Euroclass B-s1, d0

Sound absorption

1. Application in adherence - α_w up to 1.00
2. Empty air-gap - α_w up to 1.00

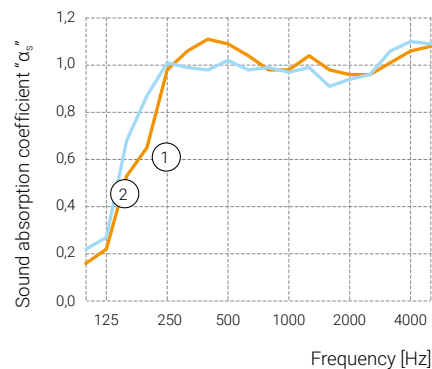

Environmental certifications

PEFC™ or FSC® certified product
ICEA - recycled material
ICEA - LEED credits attestation

Range

CELENIT ACOUSTIC MINERAL A2

Composite thermal and acoustic insulation board, in Euroclass A2-s1, d0, consisting of one or two layers of mineralized fir wood wool bound with white Portland cement and mineral powder, coupled to a layer of mineral wool according to the EN 13162 standard.

It complies with EN 13168 and EN 13964 standards.

CELENIT ACOUSTIC MINERAL A2 product range consists of the **wood wool panel which achieves superior fire-resistance**. With the addition of mineral powder in the **wood-concrete mixture, the panels attain the Euroclass A2-s1, d0**, while maintaining aesthetic appearance and the excellent sound-absorption properties.

The best safety features from the attack of flames make these panels also suitable for visible applications where fire-safety requirements are stricter.



Applications



False ceilings, wall coverings

Systems

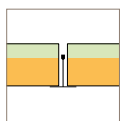

False ceilings on visible T35 profiles
CELENIT L2ABE15/A2 - CELENIT L2AB15/A2
Edge code: **DTL**

CELENIT L2ABE25/A2 - CELENIT L2AB25/A2
Edge code: **DTL-RDT-RSTL**

CELENIT L3ABE/A2
Edge code: **DT - T**

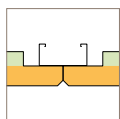

False ceilings and wall coverings with metal or wood hidden structure (rock wool 1200x500 mm)
CELENIT L2ABE25/A2 - CELENIT L2AB25/A2
Edge code: **D - S4**

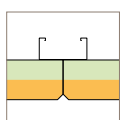

False ceilings and wall coverings with metal or wood hidden structure
CELENIT L2ABE25C/A2
Edge code: **D - S4**

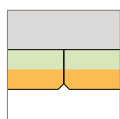

Application in adherence to the ceiling/wall
CELENIT L2ABE25C/A2
CELENIT L3ABE/A2
Edge code: **D - S4**

Technical data

Dimensions

1200x600 mm

Thickness

CELENIT L2ABE15/A2 - CELENIT L2AB15/A2
40(15/25) - 55(15/40) mm

CELENIT L2ABE25/A2 - CELENIT L2AB25/A2
50(25/25) - 65(25/40) mm

CELENIT L2ABE25C/A2
50(25/25) - 75(25/50) - 100(25/75) - 125(25/100) - 150(25/125) mm

CELENIT L3ABE/A2
25(7/15/3) - 35(10/20/5) - 50(10/35/5) mm

Reaction to fire

Euroclass A2-s1, d0

Environmental certifications

PEFC™ or FSC® certified product

PRODUCTS

Range

CELENIT BAFFLE

BAFFLE SMART

Vertical sound absorbing elements.

BAFFLE SMART consists of one CELENIT wood wool panel, thickness 25 mm, fixed with screw to a post-painted galvanized steel 10/10 mm profile, anchored to the suspension system with two perforated brackets.

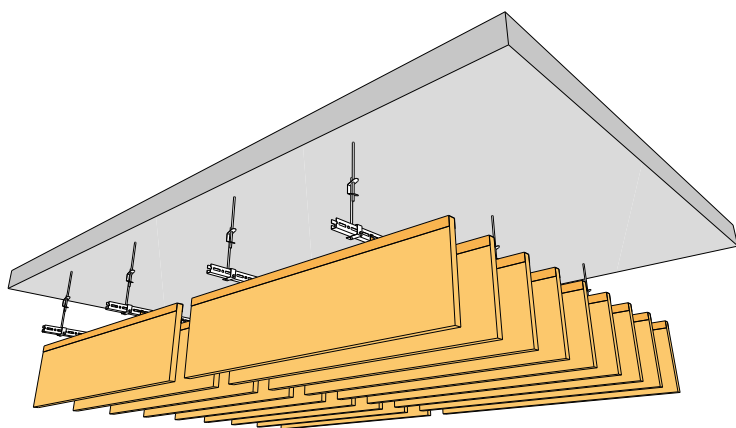
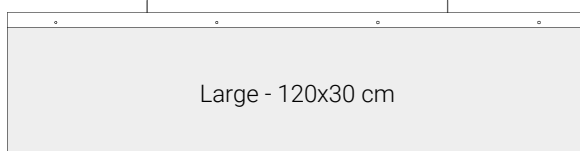
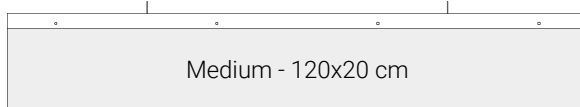
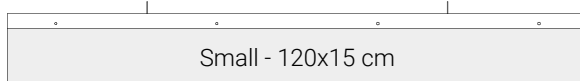

Range

CELENIT BAFFLE

BAFFLE BASIC

Vertical sound absorbing elements. BAFFLE BASIC consists of two CELENIT wood wool panels, thickness 15 mm, assembled and held together by a post-painted galvanized steel 10/10 mm frame, anchored to the suspension system with two threaded inserts.

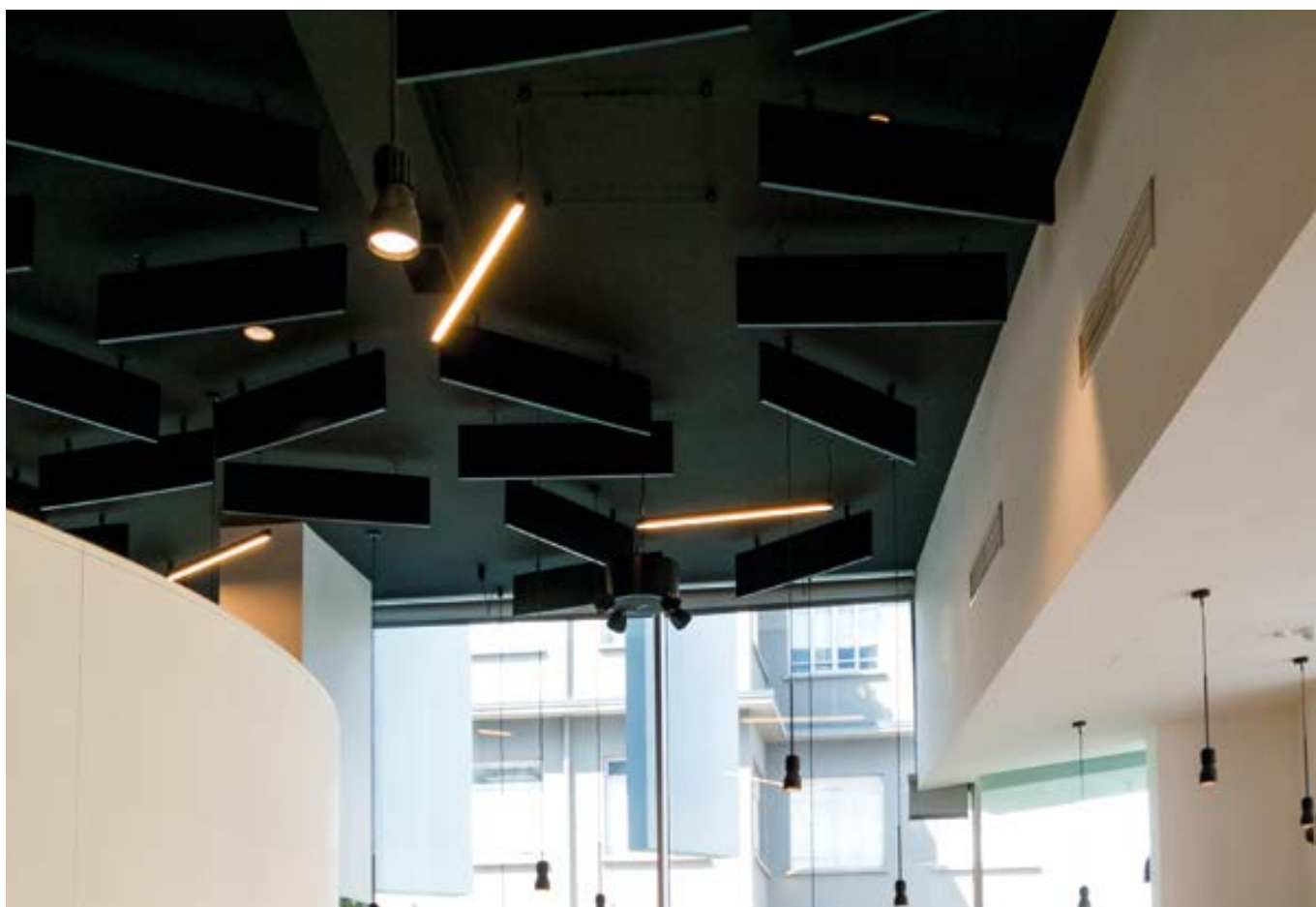
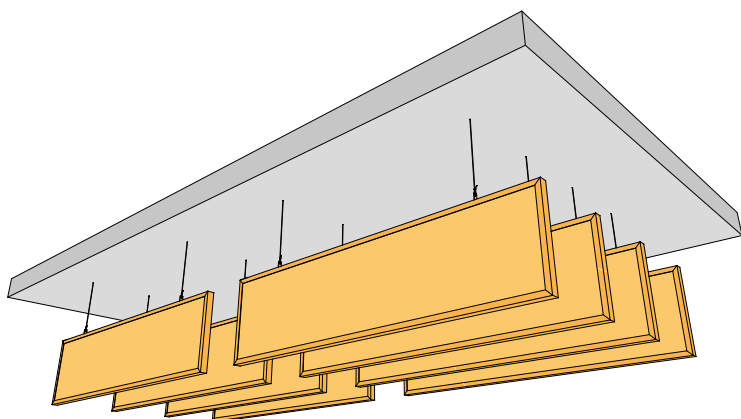

Range

CELENIT DESIGN SOLUTIONS

GROOVE

Surface processing consisting of parallel milling that creates plays of light and shadows generating a particular three-dimensional effect. Available for boards with extra-thin texture (1 mm wide - CELENIT ABE) or thin texture (2 mm wide - CELENIT AB), 25 mm minimum thickness. GROOVE is available in the NATURE version without painting, or painted.



Range

CELENIT DESIGN SOLUTIONS

LEGNOMURO

Square element consisting of mineralized extra-thin (1 mm wide - CELENIT ABE) or thin (2 mm wide - CELENIT AB) wood wool with white Portland cement.

Dimensions 29x29 cm, thickness 25 mm, chamfered edges (code S4).

LEGNOMURO is available in the NATURE version without painting, or painted.

Range

CELENIT DESIGN SOLUTIONS

SHAPES













Three-dimensional volumetric effects by combining or overlapping panels with different thicknesses. Boards can also be easily cut and work giving the possibility to create patterns with different shapes and color shades for a unique design expression.

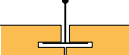

EDGES

Edges

Edge finishing and choice of colour are key elements of the board appearance. Each edge type generates a different aesthetic result and is often constrained by the chosen application and by the type of structure to which the sound-absorbing covering is fixed.

Scheme	Code	Description	Thickness [mm] *				Boards dimensions [mm]
			15	25	35	50	
Fixing with screws on hidden structure and application in adherence to the ceiling/wall							
	D	Installation on T-shaped profiles	•	•	•	•	2400x600 2000x600 1200x600 600x600
	SC	Chamfered edges on short sides					
	SL	Chamfered edges on long sides	•	•	•	•	
	S4	Chamfered edges on 4 sides					
	RD10	Shiplap edges on 4 sides with 10 mm joint width					
	RD20	Shiplap edges on 4 sides with 20 mm joint width		•	•		
Installation on T-shaped profiles							
	DT	Straight edges for T-shaped profiles	•	•			2395x595 1995x595 1195x595 595x595
	T	Straight edges for T35 profiles for boards 35 mm thick				•	
	RDT	Shiplap edges on 4 sides for T24 profiles					
	RDT35	Shiplap edges on 4 sides for T35 profiles		•	•		
	RST	Shiplap and chamfered edges on 4 sides for T24 profiles					
	RST35	Shiplap and chamfered edges on 4 sides for T35 profiles		•	•		
	PS	Chamfered edges on 4 sides for hidden T35 profiles			•	•	1200x600 600x600
	PM	Chamfered edges on 4 sides for hidden T35 profiles with removable panels				•	
	DTL	Straight edges for T35 profiles	•	•			1193x590
	RDTL	Shiplap edges on 4 sides for T35 profiles			•	•	
	RSTL	Shiplap and chamfered edges on 4 sides for T35 profiles			•	•	

* Thickness: for coupled products (except CELENIT L3ABE) it refers to the wood wool layer only

See "Edges - Summary table" in the download area of the site www.celenit.com to check all the available edges.

CELENIT L2ABE25 - CELENIT L2AB25 - CELENIT L2ABE25/A2 - CELENIT L2AB25/A2 1200x600 mm boards with straight edges (Code D) or chamfered edges (Code S4) are supplied with 1200x500 mm rock wool, for direct application to the structure of CELENIT panels. For more information contact the technical office: techsupport@celenit.com

Colors

The boards have a natural color (NATURE) that may present uneven nuances due to the natural raw materials, wood and cement, or they can be painted to ensure uniform color, without altering the acoustic performance.

NATURE



WINTER



Black
S08/14



Slate
S11/16

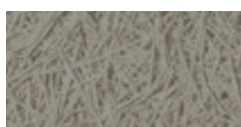

Ash grey
S07/16



Pearl grey
S08/16



White
S05/15

AUTUMN



Moka
S14/14



Brown
S11/14



Tobacco
S17/15

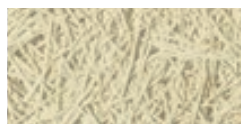

Cream
S13/15

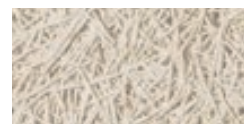

Light ochre
S08/15



Pistachio green
S25/16



Turquoise
S19/15



Night blue
S20/16



Plum
S16/16



Antique pink
S20/15

SUMMER



Green
S02/14



Azure
S01/15



Red
S13/14



Orange
S04/14



Yellow
S06/14

SPRING



Honey
B30017



Siena
B30016



Pink
B30015



Pink powder
B30014



Sage
B30011



Sky blue
B30009



Aquamarine
B30008



Gardenia
B30093



Light grey
B30007



Grey
B30006



The brand **natureplus** refers to **SPRING** colors range.
The colors reproduced here, although close to the real ones, are purely indicative.
Please ask for a sample at techsupport@celenit.com for a true reference of the tones.

Sound absorption

CELENIT boards were tested in reverberation room reproducing the three most common installations: application in adherence, empty air-gap, background filling, Baffle.

BAFFLE

Sound-absorbent modules, which, when placed vertically to the ceiling, permit creating convenient, fast and design solutions without altering the esthetics of the existing ceiling and avoid affecting pre-existing systems.

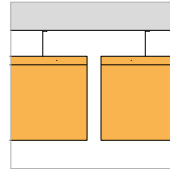

APPLICATION IN ADHERENCE

The application is divided into three types depending on the type of the board selected for the acoustic correction:

- panels fixed to the structural support (floor/wall)
- panels screwed to the support
- application with "permanent formwork" system

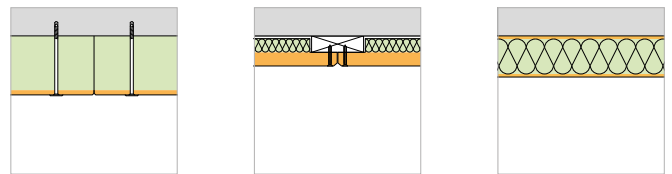

EMPTY AIR GAP

The panels can be installed on a metal or wooden structure which can be hidden by the sound-absorption covering. It is thus to create an air gap which improves the sound absorption performance of the system.

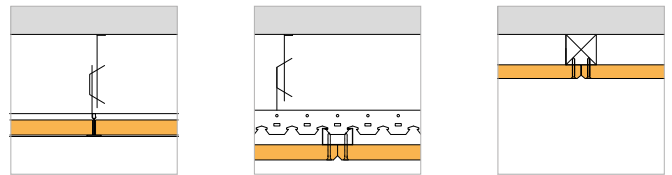

BACKGROUND FILLING

Placing a soft insulation panel made of wood fiber or rock wool you can improve the performance of the acoustic covering, especially at mid-low frequencies.

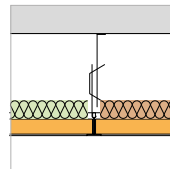

Note

¹ Paint doesn't affect sound absorption performances of CELENIT boards as described in the technical note provided by Giordano Institute dated 16.07.2015. Sound absorption values are also valid for products with grey cement.

² Test specifications

- "thickness" is relative to CELENIT board
- "MW" is the thickness of rock wool in the background - "WF" is the thickness of wood fiber CELENIT FL/45
 - (1) density 40 kg/m³ (3) density 70 kg/m³ (5) mineral wool with natural binder, density 18 kg/m³
 - (2) density 50 kg/m³ (4) density 80 kg/m³
- "TH" is the total construction height from the lower edge of ceiling to lower edge of boards.

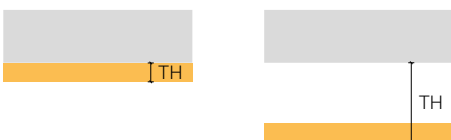

- "Lowering (R)" is the distance of the Baffle from the ceiling
- "Distance between baffles (D)" is the distance between the elements
- "Spacing between baffles (I)" is the distance between rows of elements



³ All certificate are based on tests carried out at the Giordano Institute (Bellaria - RN - Italy) according to EN ISO 354:2003 standard.

Baffle

Dimensions [mm]	Test specifications ²			Certificate ³		Sound absorption									
	Lowering (R) [mm]	Distance between baffles (D) [mm]	Spacing between baffles (l) [mm]	No.	Date	Frequencies α_p [Hz]						α_w	NRC	SAA	Class
						125	250	500	1000	2000	4000				
CELENIT BAFFLE SMART															
1200x300	0	0	300	353965-A	31.07.2018	0.20	0.25	0.20	0.30	0.45	0.60	0.30 (H)	0.30	0.30	D
1200x300	200	0	300	353965-B	31.07.2018	0.15	0.20	0.25	0.35	0.50	0.65	0.35 (H)	0.35	0.31	D
1200x300	200	300	300	353965-C	31.07.2018	0.15	0.15	0.20	0.30	0.45	0.60	0.30 (H)	0.30	0.26	D
1200x300	200	0	200	353965-D	31.07.2018	0.20	0.20	0.30	0.40	0.60	0.75	0.40 (H)	0.40	0.38	D

Application in adherence

Type of board ¹	Test specifications ²			Certificate ³		Sound absorption									
	Thickness [mm]	MW [mm]	TH [mm]	No.	Date	Frequencies α_p [Hz]						α_w	NRC	SAA	Class
						125	250	500	1000	2000	4000				
CELENIT ACOUSTIC products range															
CELENIT AB	15		15	324212-A	30.04.2015	0.05	0.10	0.20	0.35	0.75	0.60	0.30 (H)	0.35	0.35	D
CELENIT AB	25		25	331332-A	11.02.2016	0.10	0.20	0.40	0.85	0.80	0.85	0.45 (M-H)	0.55	0.56	D
CELENIT AB	35		35	333105-A	20.04.2016	0.15	0.25	0.50	0.95	0.70	0.85	0.50 (M-H)	0.60	0.60	D
CELENIT AB	50		50	324219-A	30.04.2015	0.15	0.30	0.65	0.95	0.70	0.85	0.60 (M-H)	0.65	0.64	C
CELENIT ABE	15		15	324526-A	14.05.2015	0.05	0.10	0.25	0.45	0.80	0.65	0.30 (H)	0.40	0.40	D
CELENIT ABE	25		25	331334-A	11.02.2016	0.10	0.20	0.35	0.70	0.85	0.85	0.40 (M-H)	0.55	0.53	D
CELENIT ABE	35		35	331335-A	11.02.2016	0.10	0.25	0.45	0.85	0.70	0.95	0.50 (M-H)	0.55	0.56	D
CELENIT ACOUSTIC A2 products range															
CELENIT AB/A2	25		25	331333-A	11.02.2016	0.10	0.20	0.40	0.80	0.80	0.85	0.45 (M-H)	0.55	0.55	D
CELENIT ABE/A2	25		25	324524-A	14.05.2015	0.10	0.15	0.25	0.45	0.75	0.60	0.35 (H)	0.40	0.39	D
CELENIT ACOUSTIC MINERAL products range															
CELENIT L2AB25	50		55	326376-A	20.07.2015	0.15	0.40	1.00	0.90	0.75	0.90	0.70 (M-H)	0.80	0.77	C
CELENIT L2ABE25	43		47	326172-A	14.07.2015	0.15	0.35	0.85	1.00	0.85	0.90	0.65 (M-H)	0.75	0.77	C
CELENIT L2ABE25	50		55	326172-B	14.07.2015	0.25	0.65	1.00	1.00	0.90	0.90	0.90	0.90	0.90	A
CELENIT L2ABE25	65		70	326172-C	14.07.2015	0.30	0.75	1.00	0.95	0.90	0.90	0.95	0.95	0.93	A
CELENIT L2ABE35	75		80	331339-A	11.02.2016	0.30	0.90	1.00	1.00	0.95	1.00	1.00	1.00	0.99	A
CELENIT L2ABE25C	50		50	331337-A	11.02.2016	0.20	0.55	1.00	1.00	0.95	1.00	0.85 (H)	0.90	0.87	B
CELENIT L2ABE25C	75		75	326379-B	20.07.2015	0.35	0.90	1.00	1.00	0.90	0.90	1.00	1.00	0.98	A
CELENIT L2ABE25C	100		100	326379-C	20.07.2015	0.45	1.00	1.00	1.00	0.90	0.90	1.00	1.00	0.99	A
CELENIT MINERAL A2 products range															
CELENIT L2AB/A2	50		50	326374-A	20.07.2015	0.25	0.70	1.00	1.00	0.95	0.90	0.95	0.95	0.93	A
CELENIT L2AB/A2	75		75	333108-A	20.04.2016	0.45	1.00	1.00	1.00	0.95	0.75	0.95 (L)	1.05	1.03	A
CELENIT L2AB/A2	100		100	326374-C	20.07.2015	0.55	0.85	0.95	0.95	0.95	0.90	0.95	0.90	0.92	A
CELENIT L2AB/A2	125		125	333108-C	20.04.2016	0.70	1.00	1.00	1.00	0.90	0.80	0.95 (L)	1.00	1.01	A
CELENIT L2ABE/A2	50		50	326377-A	20.07.2015	0.30	0.75	0.95	0.90	0.85	0.80	0.90	0.85	0.85	A
CELENIT L2ABE/A2	75		75	333109-A	20.04.2016	0.45	1.00	1.00	1.00	1.00	0.85	1.00	1.05	1.05	A
CELENIT L2ABE/A2	100		100	333109-B	20.04.2016	0.55	1.00	1.00	1.00	0.95	0.85	1.00	1.05	1.03	A
CELENIT L2ABE/A2	125		125	333109-C	20.04.2016	0.65	1.00	1.00	1.00	0.95	0.85	1.00	1.05	1.03	A
CELENIT L3AB/A2	50		50	324536-A	14.05.2015	0.25	0.65	1.00	1.00	1.00	0.90	0.95	0.95	0.95	A
CELENIT L3AB/A2	75		75	324537-A	14.05.2015	0.40	0.90	1.00	1.00	1.00	0.90	1.00	1.00	1.00	A
CELENIT L3AB/A2	100		100	333110-A	20.04.2016	0.60	1.00	1.00	1.00	0.95	0.85	1.00	1.00	1.01	A
CELENIT L3AB/A2	125		125	333110-B	20.04.2016	0.65	1.00	1.00	1.00	0.95	0.85	1.00	1.05	1.03	A

CERTIFICATES

Empty air gap

Type of board ¹	Test specifications ²			Certificate ³		Sound absorption									
	Thickness [mm]	MW [mm]	TH [mm]	No.	Date	Frequencies α_p [Hz]						α_w	NRC	SAA	Class
						125	250	500	1000	2000	4000				
CELENIT ACOUSTIC products range															
CELENIT AB	15		45	324213-A	30.04.2015	0.10	0.15	0.40	0.75	0.45	0.55	0.40 (M-H)	0.45	0.43	D
CELENIT AB	15		115	324213-B	30.04.2015	0.15	0.40	0.65	0.45	0.45	0.70	0.50 (H)	0.50	0.48	D
CELENIT AB	15		215	324213-E	30.04.2015	0.25	0.55	0.50	0.40	0.50	0.70	0.50 (L-H)	0.50	0.49	D
CELENIT AB	25		55	333104-A	20.04.2016	0.10	0.15	0.45	0.65	0.50	0.65	0.45 (H)	0.45	0.44	D
CELENIT AB	25		125	331332-B	11.02.2016	0.25	0.75	0.65	0.50	0.85	0.90	0.60 (L-H)	0.70	0.70	C
CELENIT AB	25		200	331332-C	11.02.2016	0.35	0.75	0.55	0.55	0.80	0.90	0.60 (L-H)	0.65	0.67	C
CELENIT AB	25		225	331332-D	11.02.2016	0.25	0.65	0.60	0.65	0.85	1.00	0.65 (H)	0.70	0.69	C
CELENIT AB	25		425	331332-E	11.02.2016	0.45	0.55	0.50	0.65	0.80	1.00	0.60 (H)	0.60	0.62	C
CELENIT AB	35		135	333105-B	20.04.2016	0.20	0.60	0.70	0.50	0.80	0.80	0.60 (H)	0.65	0.64	C
CELENIT AB	35		300	324217-D	30.04.2015	0.40	0.55	0.45	0.55	0.80	0.80	0.55 (H)	0.60	0.59	D
CELENIT AB	35		435	333105-C	20.04.2016	0.45	0.55	0.50	0.65	0.85	0.90	0.60 (H)	0.65	0.64	C
CELENIT ABE	15		45	324527-A	14.05.2015	0.10	0.15	0.45	0.80	0.55	0.60	0.45 (M-H)	0.50	0.49	D
CELENIT ABE	15		215	324527-B	14.05.2015	0.25	0.55	0.55	0.45	0.60	0.70	0.55 (H)	0.55	0.54	D
CELENIT ABE	15		300	324527-C	14.05.2015	0.30	0.55	0.45	0.55	0.60	0.75	0.55 (H)	0.55	0.54	D
CELENIT ABE	25		55	333106-A	20.04.2016	0.10	0.25	0.65	0.80	0.65	0.85	0.55 (M-H)	0.60	0.59	D
CELENIT ABE	25		75	331334-B	11.02.2016	0.15	0.35	0.80	0.75	0.70	0.95	0.65 (H)	0.65	0.64	C
CELENIT ABE	25		125	331334-C	11.02.2016	0.15	0.45	0.75	0.60	0.75	0.95	0.65 (H)	0.65	0.63	C
CELENIT ABE	25		225	331334-F	11.02.2016	0.25	0.65	0.65	0.60	0.80	1.00	0.65 (H)	0.65	0.66	C
CELENIT ABE	25		300	333106-B	20.04.2016	0.35	0.60	0.50	0.60	0.80	0.95	0.60 (H)	0.60	0.62	C
CELENIT ABE	35		65	331335-B	11.02.2016	0.15	0.30	0.75	0.85	0.75	0.95	0.60 (M-H)	0.65	0.67	C
CELENIT ABE	35		85	331335-C	11.02.2016	0.15	0.35	0.75	0.65	0.75	0.95	0.65 (H)	0.65	0.62	C
CELENIT ABE	35		235	331335-D	11.02.2016	0.30	0.70	0.60	0.70	0.90	1.00	0.70 (H)	0.70	0.72	C
CELENIT ABE	35		300	333107-A	20.04.2016	0.40	0.65	0.50	0.65	0.85	0.95	0.60 (L-H)	0.65	0.66	C
CELENIT ACOUSTIC A2 products range															
CELENIT AB/A2	25		65	331333-B	11.02.2016	0.15	0.30	0.70	0.70	0.65	0.95	0.60 (H)	0.60	0.58	C
CELENIT ABE/A2	25		300	331336-A	11.02.2016	0.30	0.60	0.50	0.65	0.80	1.00	0.60 (H)	0.65	0.64	C
CELENIT ACOUSTIC MINERAL products range															
CELENIT L2AB15	55		225	326375-A	20.07.2015	0.45	0.90	1.00	1.00	0.80	0.75	0.85 (L)	0.95	0.93	B
CELENIT L2AB25	50		225	326376-B	20.07.2015	0.40	0.90	0.85	0.95	0.75	0.90	0.85 (L)	0.90	0.88	B
CELENIT L2AB25	65		225	326376-C	20.07.2015	0.40	0.90	0.95	0.90	0.75	0.90	0.85 (L)	0.90	0.88	B
CELENIT L2ABE15	55		225	326378-A	20.07.2015	0.45	0.90	1.00	1.00	0.90	0.80	0.95	0.95	0.95	A
CELENIT L2ABE25	43		200	326172-D	14.07.2015	0.40	0.85	1.00	0.95	0.85	0.90	0.95	0.90	0.92	A
CELENIT L2ABE25	50		225	326172-E	14.07.2015	0.40	0.85	1.00	1.00	0.85	0.90	0.95	0.95	0.93	A
CELENIT L2ABE25	65		200	326172-F	14.07.2015	0.45	0.90	1.00	1.00	0.85	0.90	0.95	0.95	0.94	A
CELENIT L2ABE35	53		200	331338-A	11.02.2016	0.40	0.95	1.00	1.00	0.95	1.00	1.00	0.95	0.97	A
CELENIT L2ABE25C	50		100	331337-B	11.02.2016	0.30	0.90	1.00	1.00	0.95	1.00	1.00	0.95	0.97	A
CELENIT ACOUSTIC FIRE products range															
CELENIT AB/F	40		95	324523-A	14.05.2015	0.20	0.20	0.25	0.45	0.80	0.60	0.35 (H)	0.40	0.42	D
CELENIT AB/F	40		240	324523-B	14.05.2015	0.15	0.20	0.25	0.45	0.80	0.65	0.35 (H)	0.45	0.42	D

Background filling with rock wool





Type of board ¹	Test specifications ²			Certificate ³		Sound absorption									
	Thickness [mm]	MW [mm]	TH [mm]	No.	Date	Frequencies α_p [Hz]						α_w	NRC	SAA	Class
						125	250	500	1000	2000	4000				
CELENIT ACOUSTIC products range															
CELENIT AB	15	30 (1)	45	324212-B	30.04.2015	0.20	0.50	1.00	0.95	0.65	0.75	0.70 (M)	0.80	0.77	C
CELENIT AB	15	30 (1)	115	324213-C	30.04.2015	0.30	0.80	1.00	0.90	0.75	0.75	0.85	0.85	0.86	B
CELENIT AB	15	50 (2)	200	324213-D	30.04.2015	0.45	0.90	0.95	0.95	0.75	0.75	0.85 (L)	0.90	0.89	B
CELENIT AB	15	40 (1)	290	324213-F	30.04.2015	0.50	0.90	0.95	0.95	0.75	0.80	0.85 (L)	0.90	0.88	B
CELENIT AB	25	30 (4)	55	324214-B	30.04.2015	0.20	0.55	1.00	0.90	0.70	0.90	0.75 (M-H)	0.80	0.79	C
CELENIT AB	25	30 (1)	85	324215-B	30.04.2015	0.25	0.70	1.00	0.80	0.75	0.90	0.80	0.80	0.82	B
CELENIT AB	25	60 (1)	125	324215-D	30.04.2015	0.40	0.90	0.95	0.90	0.80	0.90	0.90	0.90	0.88	B
CELENIT AB	25	30 (4)	200	324215-E	30.04.2015	0.40	0.90	0.95	0.90	0.80	0.90	0.90	0.90	0.88	A
CELENIT AB	25	50 (3)	300	324215-F	30.04.2015	0.50	0.90	0.95	0.95	0.85	0.95	0.95	0.90	0.91	A
CELENIT AB	35	30 (4)	65	324216-B	30.04.2015	0.30	0.75	1.00	0.85	0.85	0.95	0.90	0.90	0.89	A
CELENIT AB	35	60 (1)	135	324217-B	30.04.2015	0.50	1.00	0.95	0.85	0.85	0.95	0.90 (L)	0.90	0.92	A
CELENIT AB	35	40 (4)	200	324217-C	30.04.2015	0.50	0.90	0.95	0.95	0.85	0.95	0.95	0.90	0.92	A
CELENIT AB	35	40 (1)	320	324217-E	30.04.2015	0.55	0.90	0.95	0.95	0.90	1.00	0.95	0.90	0.92	A
CELENIT ABE	15	30 (2)	45	324526-B	14.05.2015	0.20	0.60	1.00	1.00	0.80	0.75	0.85	0.90	0.88	B
CELENIT ABE	15	40 (2)	300	324527-D	14.05.2015	0.50	0.85	0.95	1.00	0.85	0.80	0.90	0.90	0.91	A
CELENIT ABE	25	30 (4)	55	324528-B	14.05.2015	0.25	0.70	1.00	0.95	0.85	0.90	0.90	0.90	0.90	B
CELENIT ABE	25	30 (1)	85	324531-B	14.05.2015	0.35	0.85	1.00	0.95	0.85	0.90	0.95	0.95	0.94	A
CELENIT ABE	25	60 (1)	125	324533-A	14.05.2015	0.50	0.95	0.95	0.95	0.85	0.95	0.95	0.95	0.93	A
CELENIT ABE	25	30 (4)	200	324531-D	14.05.2015	0.50	0.85	0.95	1.00	0.90	0.90	0.95	0.95	0.93	A
CELENIT ABE	25	50 (2)	200	331334-E	11.02.2016	0.50	1.00	1.00	1.00	0.95	1.00	1.00	1.00	0.98	A
CELENIT ABE	25	60 (5)	200	331334-D	11.02.2016	0.35	1.00	0.90	0.85	0.85	1.00	0.90 (L)	0.90	0.89	A
CELENIT ABE	25	40 (3)	225	324533-B	14.05.2015	0.50	0.90	0.95	1.00	0.85	0.95	0.95	0.95	0.93	A
CELENIT ABE	25	50 (2)	300	324531-F	14.05.2015	0.55	0.90	1.00	1.00	0.85	0.95	0.95	0.95	0.94	A
CELENIT ABE	35	30 (2)	65	324534-B	14.05.2015	0.25	0.60	1.00	0.90	0.80	0.95	0.85	0.85	0.84	B
CELENIT ABE	35	40 (2)	200	324535-B	14.05.2015	0.50	0.95	1.00	1.00	0.90	1.00	1.00	0.95	0.94	A
CELENIT ABE	35	40 (2)	300	324535-D	14.05.2015	0.55	0.90	1.00	1.00	0.90	1.00	0.95	0.95	0.93	A
CELENIT ACOUSTIC A2 products range															
CELENIT AB/A2	25	40 (2)	65	324220-B	30.04.2015	0.25	0.60	1.00	1.00	0.80	0.85	0.85	0.90	0.88	B
CELENIT AB/A2	25	60 (2)	125	324222-A	30.04.2015	0.35	0.90	1.00	1.00	0.85	0.85	0.95	0.95	0.94	A
CELENIT AB/A2	25	40 (3)	300	324222-B	30.04.2015	0.50	0.90	1.00	1.00	0.90	0.90	1.00	0.95	0.93	A
CELENIT ABE/A2	25	40 (4)	65	324524-B	14.05.2015	0.25	0.65	1.00	0.95	0.80	0.90	0.85	0.90	0.89	B
CELENIT ABE/A2	25	50 (4)	200	324525-A	14.05.2015	0.45	0.95	0.95	1.00	0.85	0.90	0.95	0.95	0.93	A
CELENIT ABE/A2	25	40 (4)	300	324525-B	14.05.2015	0.50	0.90	0.95	1.00	0.85	0.90	0.95	0.95	0.93	A

Background filling with wood fiber

Type of board ¹	Test specifications ²			Certificate ³		Sound absorption									
	Thickness [mm]	MW [mm]	TH [mm]	No.	Date	Frequencies α_p [Hz]						α_w	NRC	SAA	Class
						125	250	500	1000	2000	4000				
CELENIT ACOUSTIC products range															
CELENIT AB	25	40 (2)	65	333104-B	20.04.2016	0.25	0.60	1.00	0.85	0.75	0.95	0.80 (H)	0.80	0.81	B
CELENIT AB	25	60 (2)	200	333104-C	20.04.2016	0.40	0.90	0.85	0.85	0.80	0.95	0.85 (L)	0.85	0.86	B
CELENIT AB	25	40 (2)	300	333104-D	20.04.2016	0.50	0.90	0.85	0.90	0.85	1.00	0.90	0.85	0.87	A

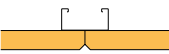
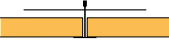
Impact resistance

according to EN 13964 and DIN 18032-3

	Type of board	Structure	Certificate	Standard	Results
Ceiling					
	CELENIT AB Thickness: 25 mm Dimensions: 1200x600 mm Edges: Chamfered - S4	C metal section 27x60x27 mm Distance between centers of cross joists: 600 mm Distance between centers of main joists: 900 mm Number of screws per board: 9	332601 31.03.2016	EN 13964 DIN 18032-3	Class 1A Pass*
	CELENIT AB Thickness: 35 mm Dimensions: 1200x600 mm Edges: Chamfered - S4	C metal section 27x60x27 mm Distance between centers of cross joists: 600 mm Distance between centers of main joists: 900 mm Number of screws per board: 9	332602 31.03.2016	EN 13964 DIN 18032-3	Class 1A Pass*
	CELENIT AB Thickness: 25 mm Dimensions: 1200x600 mm Edges: Straight - DT	Profilo metallico a "T" 24x38 mm Distance between centers of cross joists: 1200 mm Distance between centers of main joists: 600 mm Anti-lift pin: 2 per board	200535 22.08.2005	EN 13964	Class 1A
	CELENIT ABE Thickness: 25 mm Dimensions: 1200x600 mm Edges: Chamfered - S4	Wood laths section 60x30 mm Distance between centers of cross laths: 600 mm Distance between centers of main laths: 900 mm Number of screws per board: 9	332600 31.03.2016	EN 13964 DIN 18032-3	Class 1A Pass*
Wall					
	CELENIT AB Thickness: 25 mm Dimensions: 1200x600 mm Edges: Chamfered - S4	C metal section 27x60x27 mm Distance between centers of cross joists: 300 mm Distance between centers of main joists: 600 mm Number of screws per board: 9	324044 27.04.2015	DIN 18032-3	Pass*
	CELENIT AB Thickness: 35 mm Dimensions: 1200x600 mm Edges: Chamfered - S4	C metal section 27x60x27 mm Distance between centers of cross joists: 600 mm Distance between centers of main joists: 600 mm Number of screws per board: 9	324043 27.04.2015	DIN 18032-3	Pass*
	CELENIT ABE Thickness: 35 mm Dimensions: 1200x600 mm Edges: Chamfered - S4	Wood laths section 60x30 mm Distance between centers of cross laths: 600 mm Distance between centers of main laths: 600 mm Number of screws per board: 9	324042 27.04.2015	DIN 18032-3	Pass*

* After firing the shots in accordance with clause 7 "Auswertung" of standard DIN 18032-3:1997, the strength, function and safety of the wall elements are not adversely affected and their appearance has not changed.

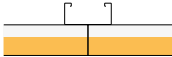

Fire resistance

	Type of board	Structure	Certificate	Standard	Results
False ceiling					
	CELENIT AB/F Thickness: 40 mm Dimensions: 1200x600 mm Edges: Straight - D	C metal section 27x50x27 mm Distance between centers of cross joists: 400 mm Distance between centers of main joists: 600 mm Distance between centers of screws: 300 mm	312748/3620FR 23.01.2014	EN 13501-2:2009	EI 60

All certificate are based on tests carried out at the Giordano Institute (Bellaria - RN - Italy).



Sustainability

Sustainability is a core issue in CELENIT's mission: producing an eco-friendly certified insulator from natural raw materials.

Certifications of raw materials and products guarantee their reliability and the respect for the environment. As an incentive to build responsibly, they become a useful tool for designers to work in conformity with the sustainability protocols standards. CELENIT products can contribute to obtaining LEED (The Leadership in Energy and Environmental Design) credits,

in order to achieve and communicate a wider perspective of sustainability and eco-construction.



Environmental Product Declaration which quantifies the environmental performance of a product through appropriate categories of parameters calculated using the Life Cycle Assessment (LCA) method and following the ISO 14040 standard.



The mark of responsible forestry
FSC® C122980

The Association promotes the conservation and the improvement of forest resources all over the world, through the economically sustainable and socially helpful management of the forest, in harmony with the international mission of the Forest Stewardship Council®, FSC®. In our manufacturing process, all wood wool boards can be made with FSC® certified wood.



PEFC is one of the main organizations of forestry certifications in the world, and it is an international non-profit, non-governmental organization, dedicated to promoting sustainable forest management. CELENIT complies with all PEFC standards for the production of its wood wool panels. All the wood wool panels are manufactured in our production process with PEFC™ certified wood.





The international association natureplus for Future-Oriented Building and Accommodation, has the mission of promoting products for sustainable construction and interior design, by assigning a mark of quality that meets the sustainability targets for the economic and social sectors the natureplus logo identifies suitable products for sustainable building. In this certificate, all CELENIT products that are natureplus certified are indicated.



ANAB (National Association of Bio-ecological Architecture) is the most important Italian association in the field of sustainable buildings and it involves professionals and operators throughout Italy. The ANAB – CERTIFIED PRODUCT FOR GREEN BUILDING logo identifies monolayer products made by wood wool with a limited environmental impact. CELENIT wood wool panels comply with building material requirements of the most important certification and building evaluation systems and provide a guarantee of the respect for human health and of the safety of end-users and workers.



The Ethical and Environmental Certification Institute (ICEA), recognizing the core importance of materials recycling for the growth of a sustainable production and consumption model, developed the “Standards for the certification of products made from recycled materials”. In this certificate, wood wool products are divided according to the percentages of recycled content. ICEA also evaluates the environmental profile through the LCA analysis and attests that CELENIT products meet the requirements of the LEED protocol credits.

All sustainability certificates are available on www.celenit.com.



CELENIT

Natural insulators made in Italy since 1963.

The history of CELENIT is the history of its founder, Gherardo Svegliado, a chemist-physicist at Montedison and mechanical engineering enthusiast. In 1963, after doing market research throughout Europe, he decided to acquire a share of small insulating panel plant. More than 50 years of know-how have been combined with one of the most efficient and automatized companies in the world to provide highly reliable thermal/acoustic eco-compatible solutions.

CELENIT operates in 20 markets and the factory based in Tombolo occupying a surface area of around 30,000 m2, has a production capacity of 10,000 panels per day. The production process is characterized by high-tech robots for the production of wood wool, automatically regulated driers and robots for pallet filling and packaging/labelling. All products placed on the Italian and European markets must have obtained the CE mark. The highly automated process ensures conformity with the production standards required by EN 13168, that specifies the requirements for wood wool products used for thermal insulation of buildings and, according to the EN 13964, that specifies the requirements for false ceilings.

Sustainability is a core issue in CELENIT's mission, that has been, since over 50 years, producing thermal and acoustic insulation made of natural and sustainable raw materials. It deals with different architectural solutions, and starts from the production of panels, and is completed by technical support to designers and companies.

CELENIT ACOUSTIC | DESIGN division provides products of high aesthetic quality for sound-absorbing coverings with visible finish, flexible design and excellent acoustic performance. **CELENIT BUILDING | CONSTRUCTION** division, offers the most suitable products for thermal and acoustic insulation fitting to traditional or innovative building structures.

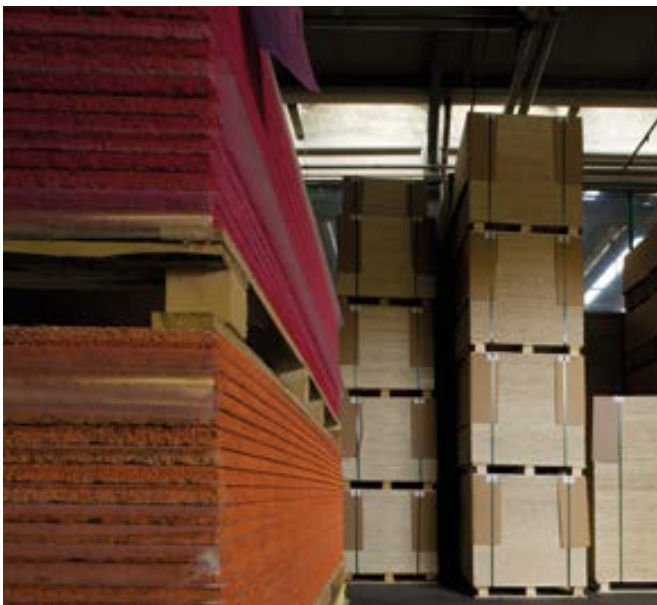
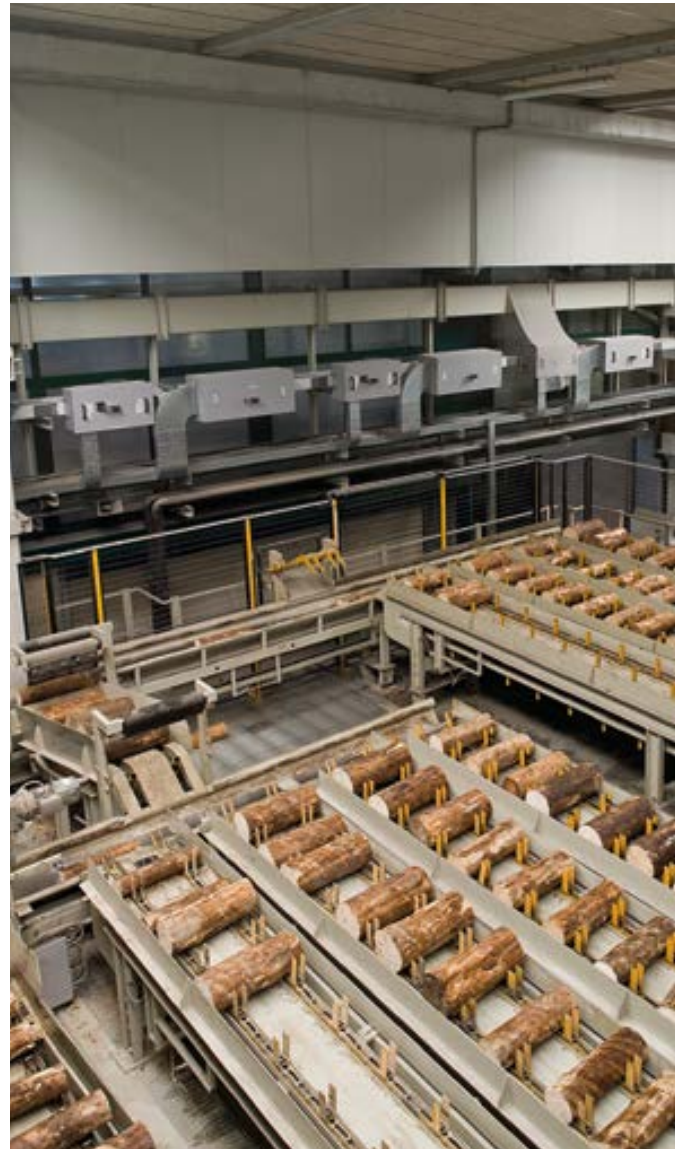

ed. 11/2018

This information is to be considered correct at the time of release. Technical documentation is delivered updated, therefore, when possible, request the most recent version from our technical office.

CELENIT S.p.A. reserves the right to make changes of any nature to improve the product range at any time without prior notice.

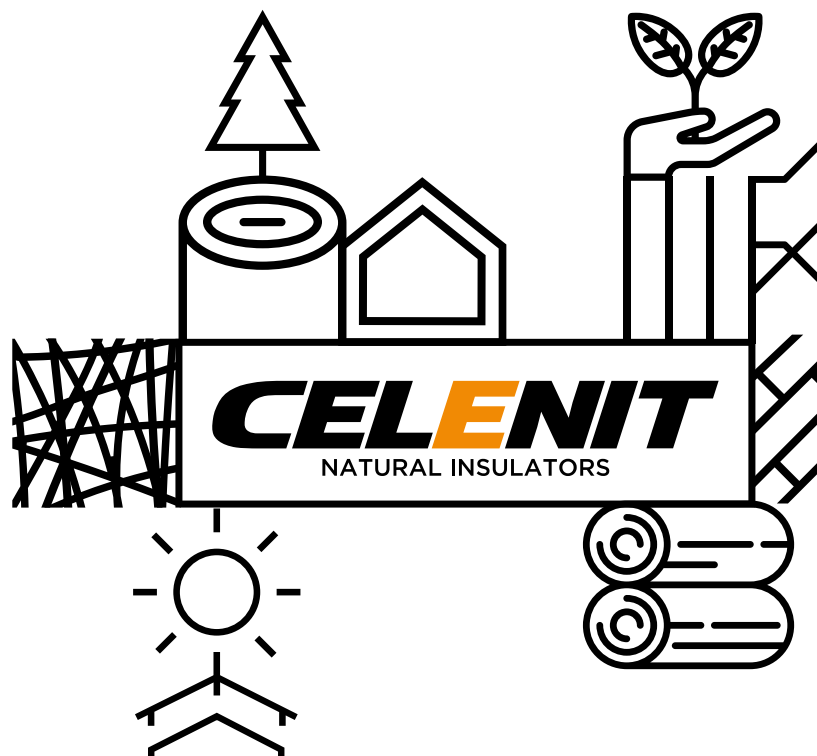

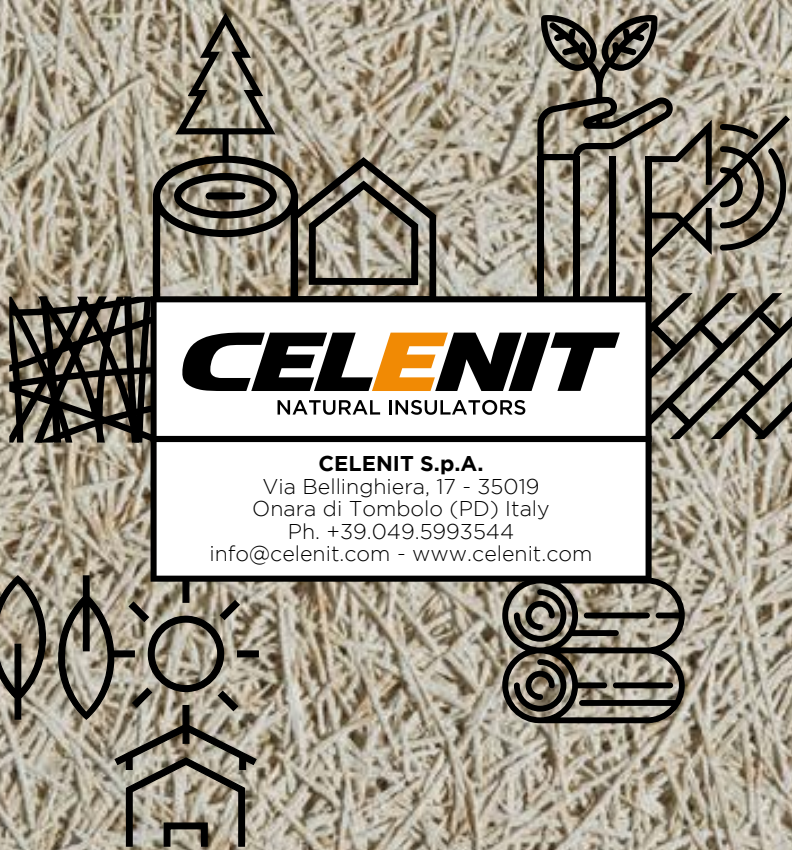

CELENIT
NATURAL INSULATORS

CELENIT S.p.A.
Via Bellinghiera, 17 - 35019
Onara di Tombolo (PD) Italy
Ph. +39.049.5993544
info@celenit.com - www.celenit.com