

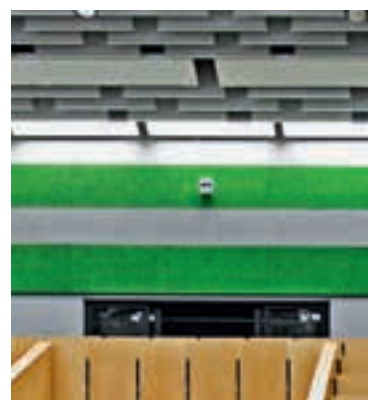

Heradesign®

Product Catalogue





Knauf AMF

Complete system solutions expertise for the modular ceiling – from one source with strong product brands.

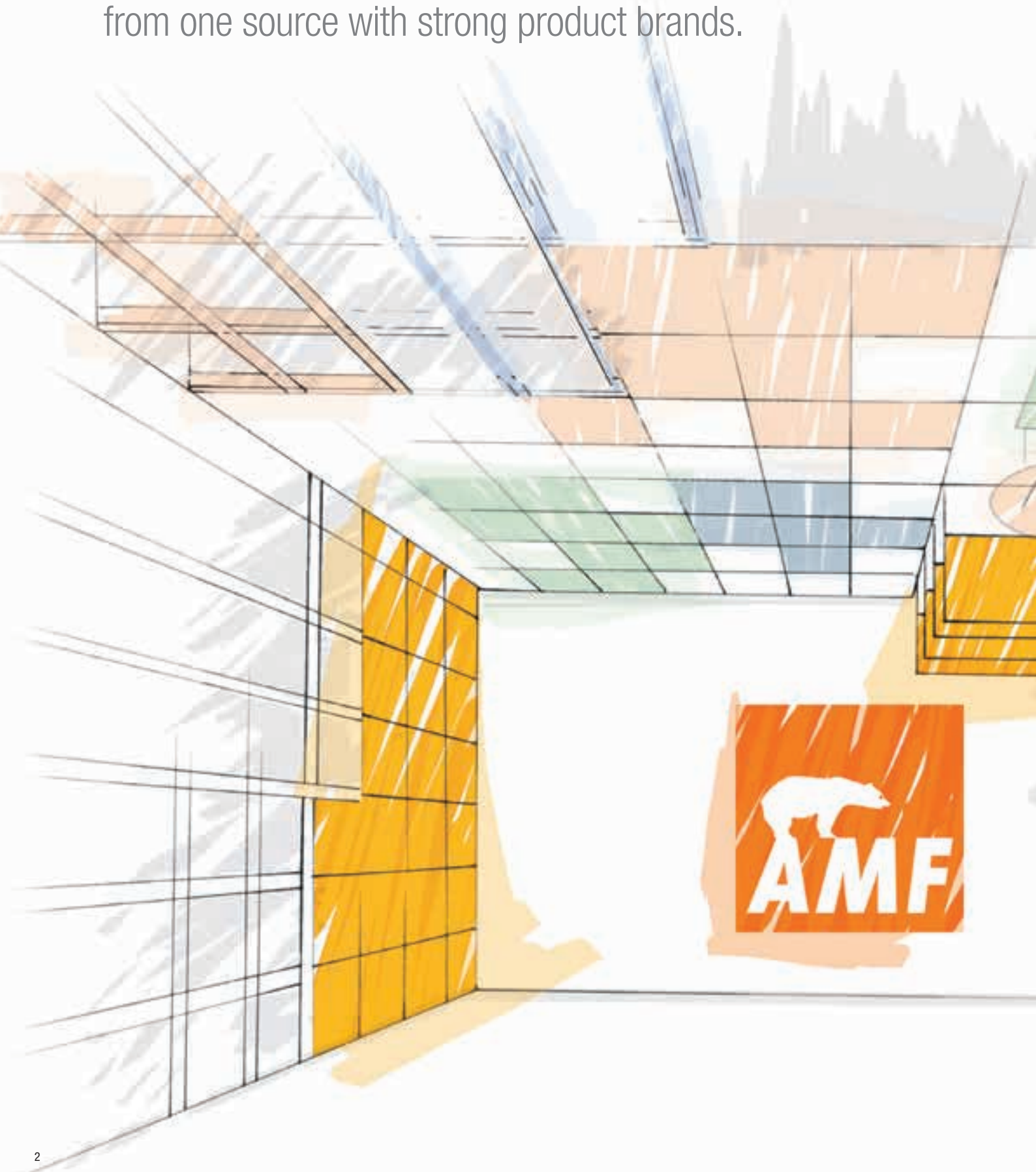

HERADESIGN® – “creative and diversely- unconventional“

This is how sustainable acoustics look.
The high quality wood wool acoustic solutions
open up an almost infinite variety of designs
and make an essential contribution to
creating ecological, liveable rooms.

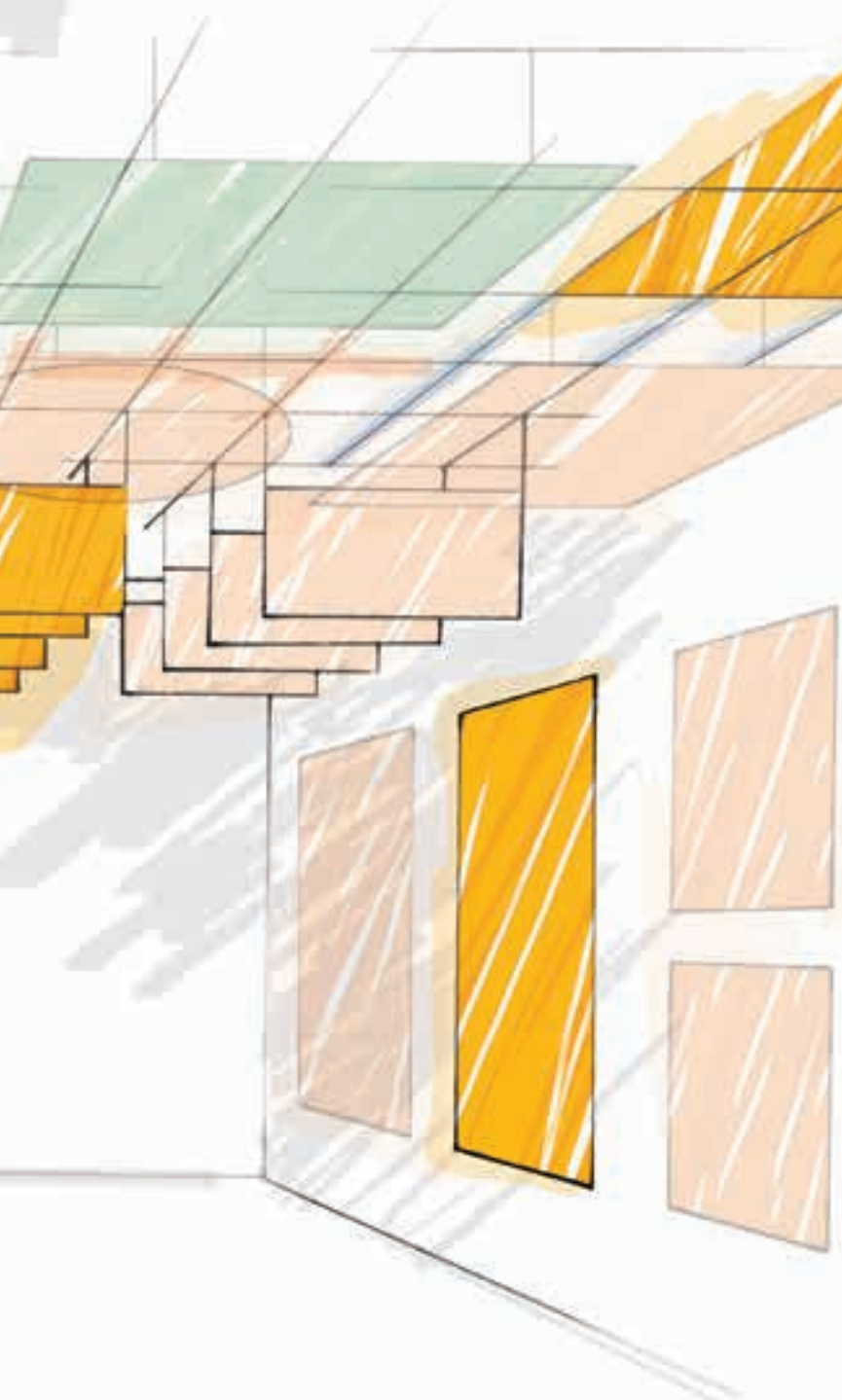

Introduction

| | |
|--------------------|----|
| Acoustics | 07 |
| Timeline | 08 |
| Sustainability | 10 |
| Product properties | 13 |

| | |
|------------|-------|
| References | 14-21 |
|------------|-------|

| | |
|---------------|----|
| Product Range | 22 |
|---------------|----|

| | |
|---------|----|
| Colours | 24 |
|---------|----|

Products

| | |
|------------------------------|----|
| HERADESIGN® <i>macro</i> | 27 |
| HERADESIGN® <i>fine</i> | 28 |
| HERADESIGN® <i>superfine</i> | 29 |
| HERADESIGN® <i>micro</i> | 30 |
| HERADESIGN® <i>plano</i> | 31 |
| Product Range <i>A2</i> | 32 |
| Product Range <i>plus</i> | 34 |

Systems

| | |
|--------------------------|----|
| Baffles | 38 |
| Ceiling rafts | 40 |
| Grid installation system | 41 |

Constructions

| | |
|---|----|
| Screw mounting onto wood laths | 44 |
| Screw mounting onto CD sections | 45 |
| Suspended ceiling with visible T-sections | 46 |
| Suspended ceiling with concealed T-sections | 47 |
| Knauf AMF grid systems | 48 |
| Concealed T-profile VK-10 | 49 |
| Wall mounting with HERADESIGN® holding profiles | 50 |

| | |
|--------------------------|----|
| Installation information | 52 |
|--------------------------|----|

| | |
|--------------|----|
| System edges | 56 |
|--------------|----|

| | |
|-----------------|----|
| Customer quotes | 58 |
|-----------------|----|

worldwide ceiling systems
wall mounting architecture acoustics
design sustainable timeless
nature acoustic solutions

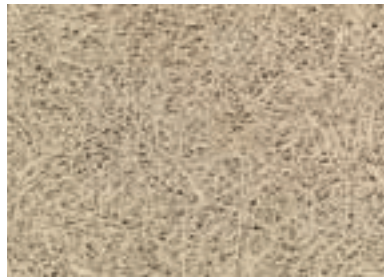

Sustainable acoustic solutions
for feel-good rooms



The demand for a positive environment that is worth living in is higher than ever before. This forms the blueprint for architects, planners and building owners all over the world. It is our job to provide them with products that enable them to fulfil this challenge.

With the high-quality HERADESIGN® acoustic solutions, made of ecologically sound materials and with a focus on functionality and in an almost unlimited variety of design options, we are making a conscious contribution to creating contemporary living spaces.

HERADESIGN®.
That's what sustainable acoustics look like.



silence
room atmosphere acoustics relaxation
well-being entertainment

HERADESIGN® acoustic solutions reduce all disturbing background noise. Well, almost all, as there can be sources of noise that even we are powerless to control. Not all nuisances are obvious nor do they all result from noise. For a pleasant, positive room ambience it is not only important what we hear, but in particular what we feel.

HERADESIGN® has been dealing with the complexities of acoustics for decades. Besides the study of noise and acoustics, for us this means the development of sustainable, acoustically optimised solutions. Acoustics is one of the most important factors affecting the well-being, mood and temper of people – even if they are not aware of it.

Under the product brand **HERADESIGN®**, Knauf AMF produces, develops and distributes high-class acoustic systems based on wood wool for ceiling and wall installations. These excel through a unique, timeless design character and a multitude of creative options. The high quality and 'warm' character of the wood wool structure makes our products unmistakable. A wealth of knowledge, decades of experience and the company's traditional origins combine to provide outstanding acoustic solutions that improve well-being as well as performance. Relaxation and concentration lead to success!

The main fields of application of the **HERADESIGN®** acoustic systems are education, sports, office, infrastructure, entertainment and recreational facilities.

In this Product Catalogue you can learn more about the variety of our products, their outstanding sound absorption values and the design options of **HERADESIGN®** acoustic solutions.

Questions?

Contact our technical
information service AMF direct

Tel.: +43 4245 2001-0

E-Mail: heradesign@knaufamf.com

to receive simple and uncomplicated
information and test certificates.



1935

1976

1908 1920 | 1940 1945 1950 1955 1960 1965 1970 1975 | 1980



Club hall of the football club Ajax Amsterdam, 1935



Airport terminal, Aruba Airport, 1976

Timelessly modern and in demand worldwide

Success stories like the story of the magnesite bonded wood wool panel are always a combination of a clear vision, innovation and consistency. Introduced as a revolutionary building product in 1908, the wood wool panel has undergone a dramatic development. With the first steps towards function and design, the path to becoming a cult object began in 1935. From Japan to America, from Finland to South Africa, it was and still is the eye-catcher in many well-known buildings, and not only on the ceiling. Highly functional and timelessly attractive, it has stood the tests of changing architectural styles and functional requirements.

HERADESIGN®, with headquarters in Ferndorf, Austria, has been a brand of Knauf AMF Deckensysteme GmbH since 2013.

2005 2012

1985 1990 1995 2000 2010 2011 2013 2014 2015 2016

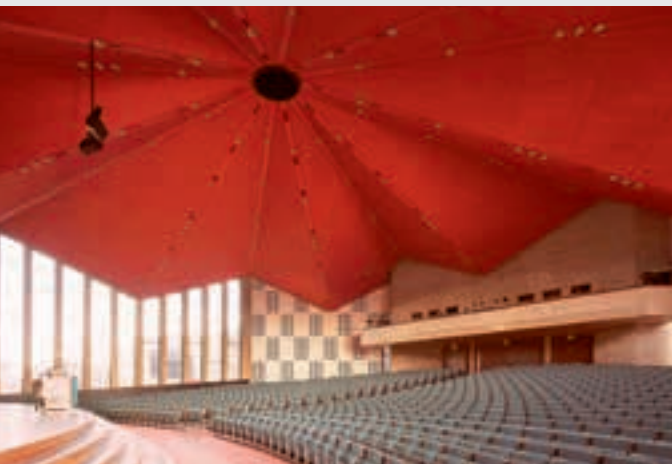

Erasmus University, Rotterdam



Rhein-Waal University



Institut Bauen
und Umwelt e.V.



The mark of
responsible forestry
FSC™ C120661



0751 / 03

“In the green zone”

By using high-quality raw materials and innovative production technologies, **HERADESIGN®** wood wool acoustic panels offer a multitude of design possibilities and applications.

Thanks to their outstanding sound absorption, as well as the use of sustainable materials and technologies, the **HERADESIGN®** acoustic solutions make a major contribution to the improvement of the ambience of a room. They increase well-being and, as a result, improve concentration, efficiency and performance.

HERADESIGN® acoustic solutions are ecologically sound and completely harmless as regards building biology. Acoustics and design with a clear, “green conscience”!





Sustainable. Functional.

Wood, water and magnesite are the principal components of HERADESIGN® acoustic panels – so they have a completely neutral biological footprint. HERADESIGN®'s magnesite bonded wood wool panels are natural products and so ideal for modern lifestyles.

HERADESIGN® acoustic panels can last more than 80 years in buildings. Should it one day be necessary: magnesite bonded wood wool panels can be disposed of easily or recycled.



Open and smooth surface texture

Only with the technologies and quality standards developed by **HERADESIGN®** is it possible to create open, smooth and lightweight surface textures with a simultaneously low quantity of binding agents. This unique structure gives the panels an exquisite and exclusive character and means they can be used in high-quality interior applications.



Dimensional accuracy and tolerances

The sheet forming technology exclusive to **HERADESIGN®** means a standard thickness deviation of only +/- 1 mm.



A variety of edge designs

The production technology and binding agent make exact and high-quality edge designs compatible with almost all ceiling systems and profiles on the market.



Sound absorption

In addition to decorative applications in wall and ceiling constructions, **HERADESIGN®** acoustic panels can reach sound absorption values of up to $\alpha_w = 1.0$.



Fire resistance – non-combustibility (A2)

HERADESIGN® acoustic panels have a standard B – s1, d0 fire resistance class. In addition, **HERADESIGN® superfine A2** and **HERADESIGN® fine A2** are available in fire resistance class A2 – s1, d0!



High mechanical strength

Crash test with 90 km/h – **HERADESIGN®** acoustic panels pass the ball-impact test to DIN 18032 and EN 13964 with flying colours! This is also a result of using magnesite as a binding agent, which guarantees both durable fibre elasticity and solidity.



Long lifespan

Suitable for indoor conditions with relative air humidity of up to 90%. Magnesite protects the wood cells against ageing and fungal attack.



Humidity and climate regulation

Magnesite is recognised as a hygroscopic and biologically sound binding agent. This means that in addition to their acoustic and decorative properties, **HERADESIGN®** acoustic panels also regulate room humidity and climate.



Low shrinkage

HERADESIGN® acoustic panels are delivered with optimally balanced moisture content and will therefore shrink only 1 mm after installation. As a result, ceiling joints remain practically invisible.



Nature meets modern living

In addition to having received the “building biology harmless” certificate (Institute for Building Biology in Rosenheim), **HERADESIGN®** has a sustainability and conservation policy regarding product technology and raw material use (EPD – AUB Environmental Product Declaration acc. to EN ISO 14025).



High-quality and sustainable raw materials

In magnesite, **HERADESIGN®** has found the ideal binding agent for wood fibres. Magnesite protects the fibres and maintains their flexibility. Furthermore, only wood from sustainable Austrian forestry is used for the manufacturing process (PEFC and FSC™ certified).



Product portfolio

HERADESIGN® is the only manufacturer of visible wood wool applications that also offers decorative sealed pored surfaces in addition to the classic fibre surfaces.

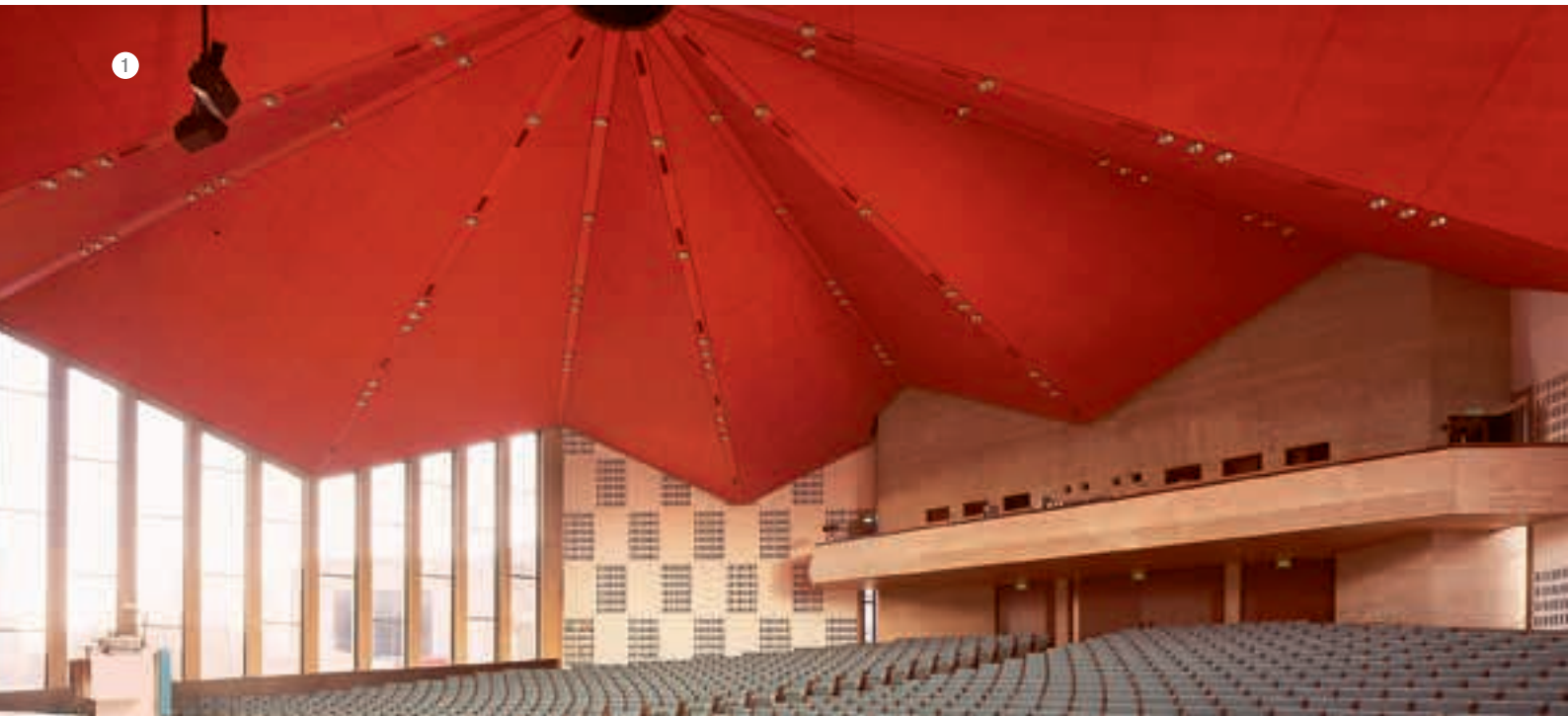

From sensual to exotic, from classical to plain, from extravagant to subtle: HERADESIGN®'s many national and international reference properties can be described in a number of ways. They all have one thing in common: they have all used a sophisticated product range which can adapt to different styles and demands worldwide. Draw inspiration from a trip through a world of previously unimagined design possibilities.

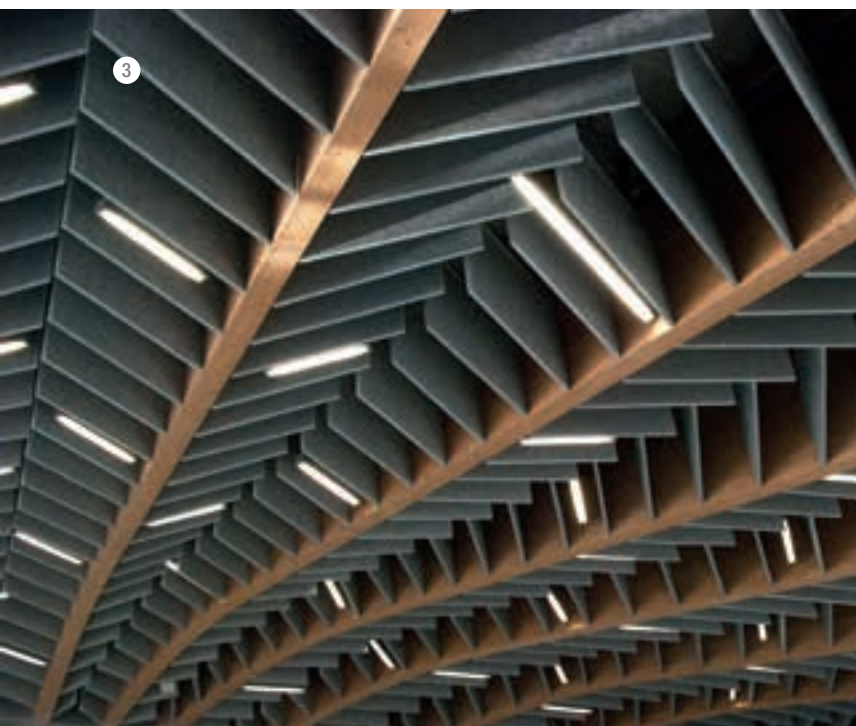

- ① Erasmus University, Rotterdam, the Netherlands, HERADESIGN® *superfine*
- ② Bartle Bogle Hegarty, London HQ, England, HERADESIGN® *superfine*
- ③ Atrium University of Lublin, Poland, HERADESIGN® *superfine*
- ④ McDonald's, Paris, France, HERADESIGN® *superfine*
- ⑤ University of Lucerne, Switzerland, HERADESIGN® *superfine*



- ① Primary school, Bentwisch, Germany, HERADESIGN® *superfine*
- ② VillAma, Turku, Finland, HERADESIGN® *superfine*
- ③ Leiden University, the Netherlands, HERADESIGN® *fine*

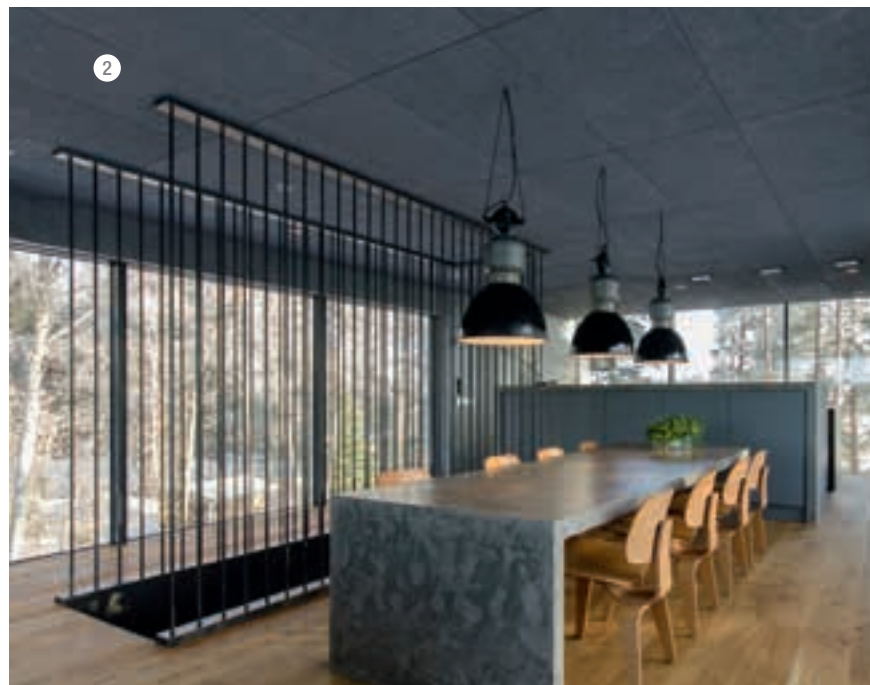



3

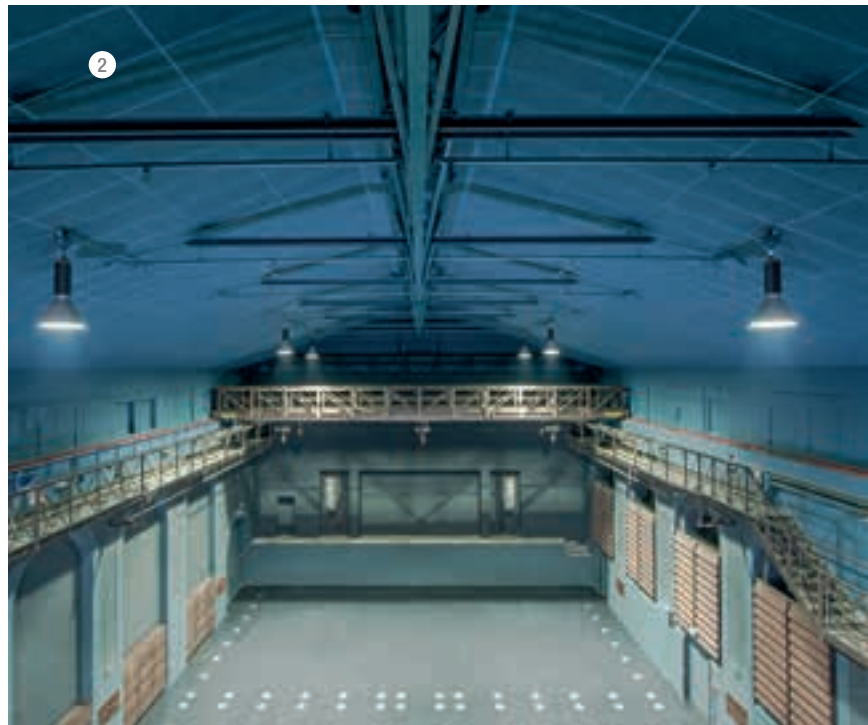



- ① Fitness centre, Olympic Swimming Pool, Munich, Germany, HERADESIGN® *superfine*
- ② Muffat Hall, Munich, Germany, HERADESIGN® *superfine*
- ③ Sports Hall, Bieruń, Poland, HERADESIGN® *superfine*
- ④ engelbert strauss GmbH, Hockenheim, Germany, HERADESIGN® *superfine*
- ⑤ AachenMünchener, Germany, HERADESIGN® *fine*

1





2

- ① Sophia Revalidation Centre, the Hague, the Netherlands, HERADESIGN® *fine*
- ② Showroom Jolo Fashion, the Netherlands, HERADESIGN® *fine*
- ③ Shooting range HSG, Munich, Germany, HERADESIGN® *superfine*

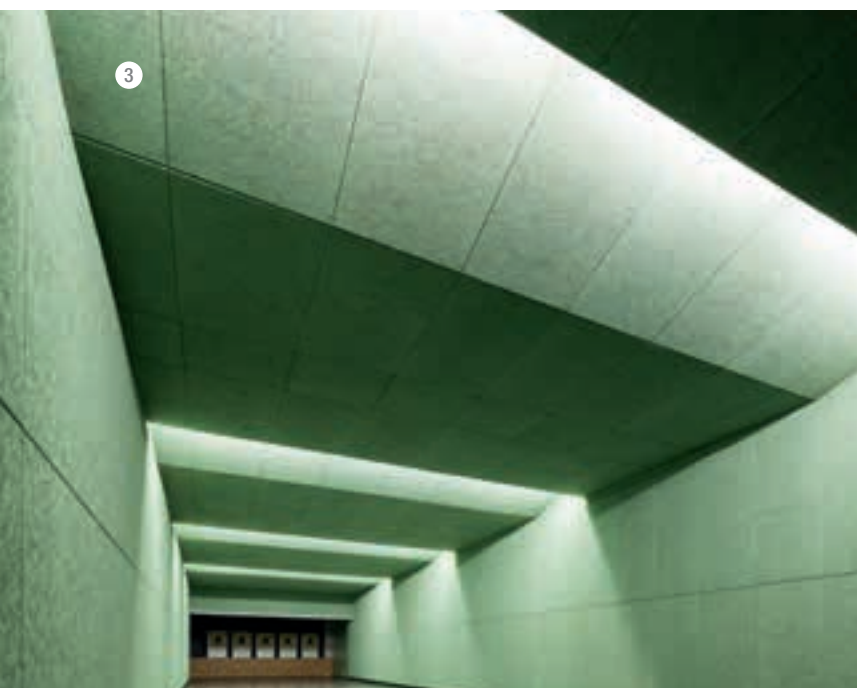

3

HERADESIGN® acoustic solutions

Have you seen the ribbon in the HERADESIGN® logo? It stands for the infinite variety of acoustic solutions HERADESIGN® offers. Whether they are used for ceilings or walls, with a characteristic wood wool appearance, or whether you prefer a neutral, colourful or rather a natural look, for acoustics all over the room or focussed on a specific area ... the options are endless!

| Product Range | | | | | | | |
|---|---------------|---------------|--------------|-------------|------------------|--------------|--|
| | | | <i>macro</i> | <i>fine</i> | <i>superfine</i> | <i>micro</i> | <i>plano</i> |
| Nominal size mm (further sizes on request) | 600 x 600 mm | | • | • | • | • | • |
| | 625 x 625 mm | | – | • | • | • | – |
| | 1200 x 600 mm | | • | • | • | • | • |
| | 1250 x 625 mm | | – | • | • | • | – |
| Panel thicknesses | 1-layer | 15 mm | – | • | • | – | – |
| | | 25 mm | • | • | • | • | • |
| | | 35 mm | – | • | • | • | – |
| | 2-layer | 40 mm (15/25) | – | – | – | – | – |
| | | 50 mm (25/25) | – | – | – | – | – |
| | | 55 mm (15/40) | – | – | – | – | – |
| | | 65 mm (25/40) | – | – | – | – | – |
| Reaction to fire according to EN 13501-1: B-s1, d0 | | | • | • | • | • | • |
| Reaction to fire according to EN 13501-1: A2-s1, d0 | | | – | – | – | – | – |
| Sound absorption value | | | | | | | |
| Weighted sound absorption coefficient α_w | | | up to 0.70 | up to 0.90 | up to 1.00 | up to 0.55 | up to 0.35 |
| Noise reduction coefficient <i>NRC</i> | | | up to 0.75 | up to 0.95 | up to 1.00 | up to 0.60 | up to 0.35 |
| Product declaration | | | | | | | |
| WW-EN 13168-L3-W2-T2-S3-P2-CS(10)200-CI3 | | | • | • | • | • | • |
| WW-EN 13168-L3-W2-T2-S3-P2-CS(10)20-TR5-CI3 | | | – | – | – | – | – |
| Certificate of constancy of performance | | | | | | | 0751-CPR-209.0-01 |
| Standard colours | | | | | | | White, similar to RAL 9010 / beige – natural tone 13 |
| Areas of application | | | | | | | Suitable for rooms with constant relative humidity of up to 90%. |

HERADESIGN®
macro



HERADESIGN®
fine

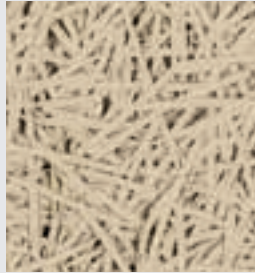

HERADESIGN®
superfine

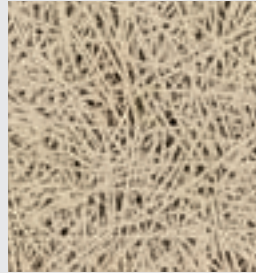

HERADESIGN®
micro

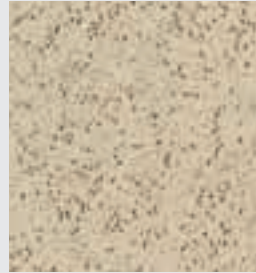

HERADESIGN®
plano

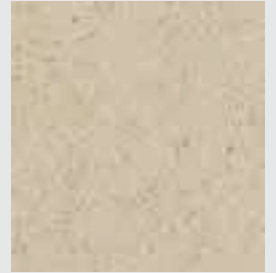

Product Range A2

fine A2

superfine A2

•

•

–

–

•

•

–

–

•

•

•

•

–

–

–

–

–

–

–

–

–

–

–

–

•

•

up to 0.75

up to 0.95

up to 0.75

up to 1.00

•

•

–

–

Product Range plus

macro plus

fine plus

superfine plus

micro plus

plano plus

–

–

–

–

–

–

–

–

–

–

•

•

•

•

•

–

–

–

–

–

–

–

–

–

–

–

–

–

–

–

•

•

•

•

•

•

•

•

•

•

•

•

•

•

•

•

•

•

•

•

•

•

•

•

•

•

•

•

•

•

–

•

•

–

–

up to 0.75

up to 0.85

up to 0.95

up to 0.35

up to 0.40

up to 0.85

up to 0.85

up to 0.95

up to 0.35

up to 0.45

–

–

–

–

–

•

•

•

•

•

0751-CPR-209.0-02

(further shades available from colour systems such as RAL, NCS, BS or StoColor)

Application in rooms with relative humidity higher than 80% should be discussed with a structural engineer.

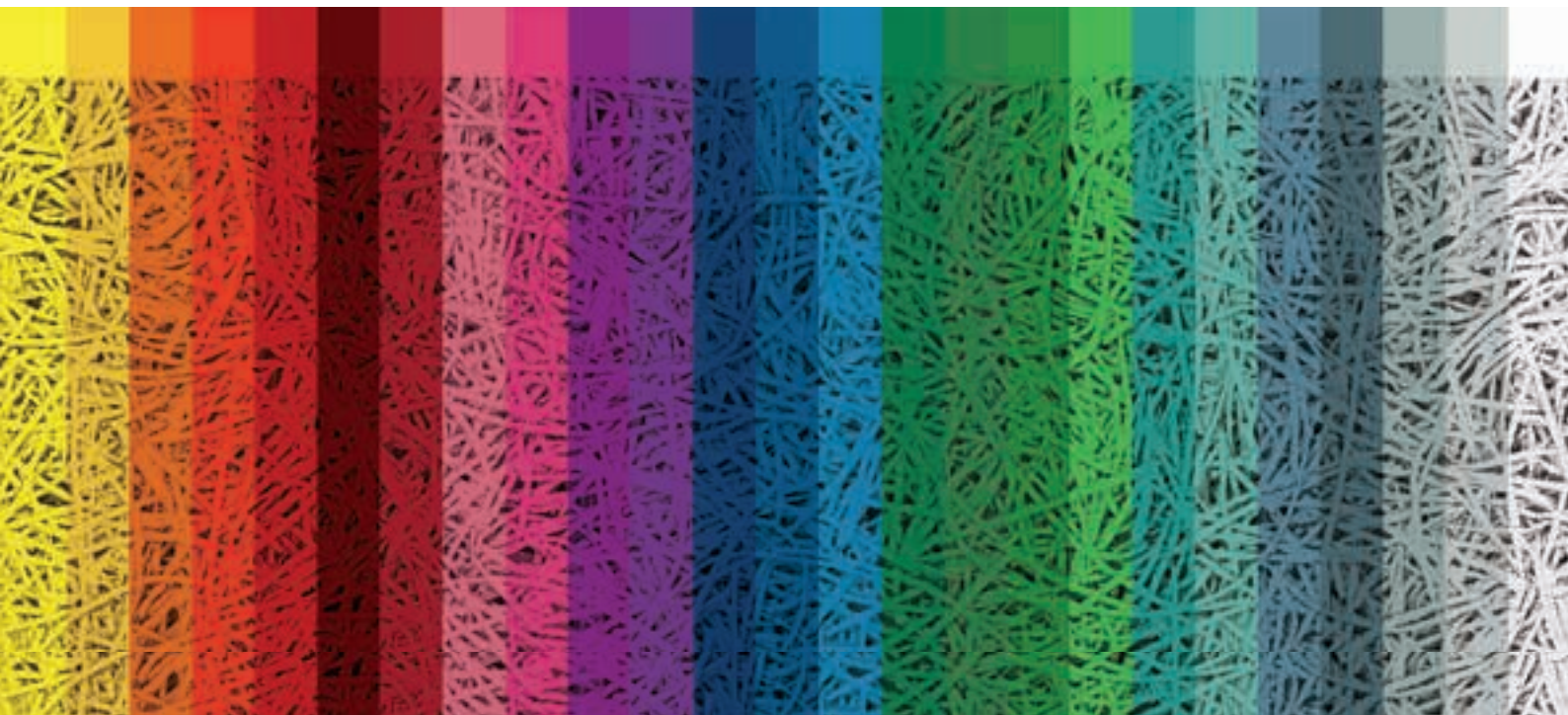

Colours

It is not just the quality of acoustics which is important to us – we also offer great aesthetic solutions. The typical, stable surface texture of the wood wool panels is perfect for creative design and colouring. An almost unlimited range of colours is available – you can choose almost any colour from popular colour systems such as RAL, NCS or StoColor.

Silicate paints based on potassium silicate and an organic binding agent are used to colour the HERADESIGN® acoustic panels in white, pastel shades or solid colours. What's more, great effects can be achieved with the twelve trendy metallic colours.

We also offer a special colour quality standard for application in indoor swimming pools, semi-external, etc.



- ① Rhein-Waal University, Kleve, Germany, HERADESIGN® *superfine*
- ② Klangwelten, Austria, HERADESIGN® *fine*
- ③ Therme Wien, Austria, photo credits: © Cathrine Stukhard, HERADESIGN® *superfine*





HERADESIGN[®] *macro*

1-layer magnesite bonded
wood wool acoustic panel
(fibre width approx. 3 mm)

- Characteristic surface texture
- Building biology recommended



Product range for HERADESIGN[®] *macro*

| | | |
|--|---------|---------------|
| Nominal size mm (further sizes on request) | | 600 x 600 mm |
| | | 1200 x 600 mm |
| Thickness | 1-layer | 25 mm |
| Weight kg/m ² | | 12.4 |
| ABZ General Building Approval: Z-23.15-1562 | | |
| Reaction to fire according to EN 13501-1: B-s1, d0 | | |
| Special formats on request. Length of max. 2400 mm | | |

Sound absorption values

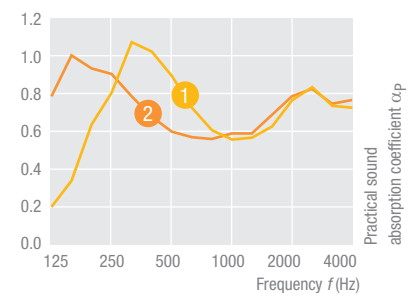

1 α_w up to 0.70 $NRC =$ up to 0.75



with acoustic lining

2 α_w up to 0.70 $NRC =$ up to 0.75

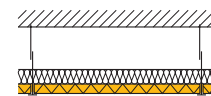

suspended with acoustic lining



Extensive detailed information and sketches can be found at www.heradesign.com.

HERADESIGN[®] *fine*

1-layer magnesite bonded
wood wool acoustic panel
(fibre width 2 mm)

- Characteristic surface texture
- Building biology recommended

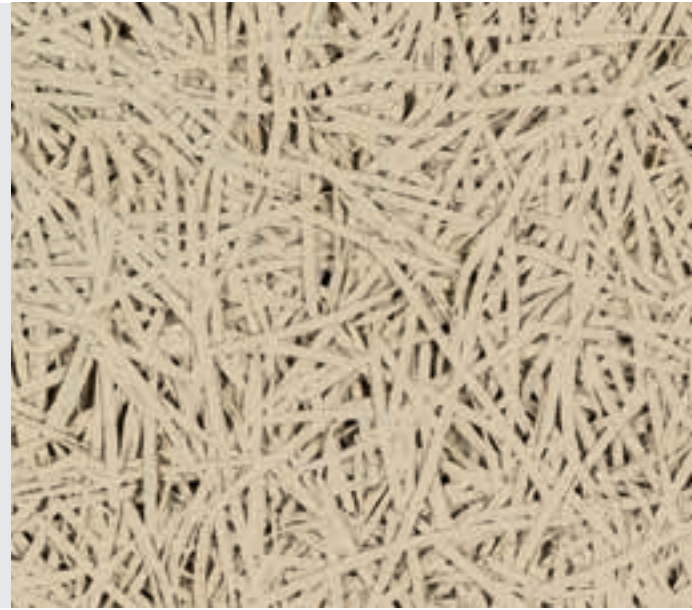

Product range for HERADESIGN[®] *fine*

| | | |
|--|---------|---------------|
| Nominal size mm (further sizes on request) | | 600 x 600 mm |
| | | 625 x 625 mm |
| | | 1200 x 600 mm |
| | | 1250 x 625 mm |
| Thickness | 1-layer | 15 mm |
| | | 25 mm |
| | | 35 mm |
| Weight kg/m ² | | 8.2 (15 mm) |
| | | 12.4 (25 mm) |
| | | 16.3 (35 mm) |
| ABZ General Building Approval: Z-23.15-1562 | | |
| Reaction to fire according to EN 13501-1: B-s1, d0 | | |
| Special formats on request. Length of max. 2400 mm | | |

Sound absorption values

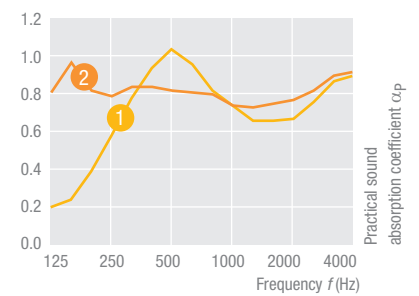

1 α_w up to 0.80 $NRC =$ up to 0.85



with acoustic lining

2 α_w up to 0.90 $NRC =$ up to 0.90

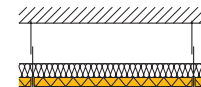

suspended with acoustic lining

HERADESIGN[®] *superfine*

1-layer magnesite bonded wood wool acoustic panel (fibre width approx. 1 mm)

- Fine surface texture
- Building biology recommended

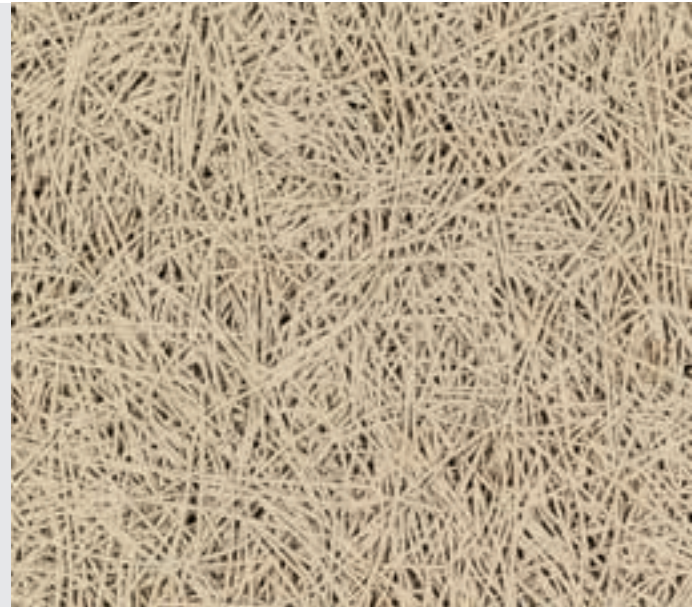

Product range for HERADESIGN[®] *superfine*

| | | |
|--|---------|---------------|
| Nominal size mm (further sizes on request) | | 600 x 600 mm |
| | | 625 x 625 mm |
| | | 1200 x 600 mm |
| | | 1250 x 625 mm |
| Thickness | 1-layer | 15 mm |
| | | 25 mm |
| | | 35 mm |
| Weight kg/m ² | | 7.8 (15 mm) |
| | | 11.3 (25 mm) |
| | | 15.0 (35 mm) |
| ABZ General Building Approval: Z-23.15-1562 | | |
| Reaction to fire according to EN 13501-1: B-s1, d0 | | |
| Special formats on request. Length of max. 2400 mm | | |

Sound absorption values

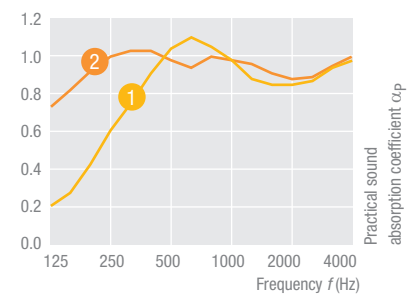

1 α_w up to 0.85 $NRC =$ up to 0.85



with acoustic lining

2 α_w up to 1.00 $NRC =$ up to 1.00

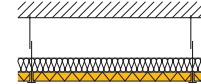

suspended with acoustic lining



Extensive detailed information and sketches can be found at www.heradesign.com.

HERADESIGN[®] *micro*

1-layer magnesite bonded
wood wool acoustic panel

- Fine pored surface texture
- Building biology recommended



Product range for HERADESIGN[®] *micro*

| | | |
|--|---------|---------------|
| Nominal size mm (further sizes on request) | | 600 x 600 mm |
| | | 625 x 625 mm |
| | | 1200 x 600 mm |
| | | 1250 x 625 mm |
| Thickness | 1-layer | 25 mm |
| | | 35 mm |
| Weight kg/m ² | | 15.0 (25 mm) |
| | | 19.0 (35 mm) |
| ABZ General Building Approval: Z-23.15-1562 | | |
| Reaction to fire according to EN 13501-1: B-s1, d0 | | |
| Special formats on request. Length of max. 2400 mm | | |

Sound absorption values

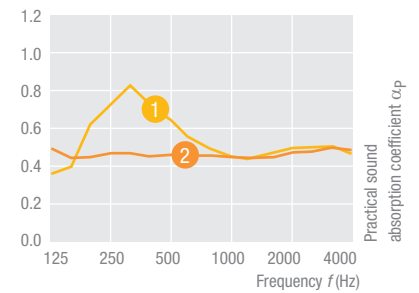

- 1 α_w up to 0.35 NRC = up to 0.35



with acoustic lining

- 2 α_w up to 0.45 NRC = up to 0.40

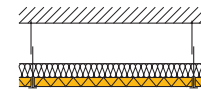

suspended with acoustic lining

HERADESIGN[®] *plano*

1-layer magnesite bonded wood wool acoustic panel (fibre width approx. 1 mm)

- Fine surface texture
- Building biology recommended



Product range for HERADESIGN[®] *plano*

| | | |
|--|---------|---------------|
| Nominal size mm (further sizes on request) | | 600 x 600 mm |
| | | 1200 x 600 mm |
| Thickness | 1-layer | 25 mm |
| Weight kg/m ² | | 15.0 |
| ABZ General Building Approval: Z-23.15-1562 | | |
| Reaction to fire according to EN 13501-1: B-s1, d0 | | |
| Special formats on request. Length of max. 2400 mm | | |

Sound absorption values

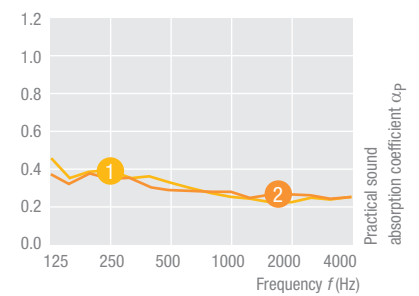

1 α_w up to 0.30 $NRC =$ up to 0.30

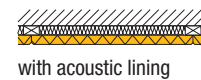

2 α_w up to 0.30 $NRC =$ up to 0.30

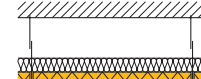

Extensive detailed information and sketches can be found at www.heradesign.com.

Product Range A2



Acoustic panel for increased fire resistance.

- Non-combustible wood wool: acoustic panel with reaction to fire according to DIN-EN 13501-1: A2-s1, d0
- Excellent acoustic properties
- Building biology recommended

HERADESIGN® *fine A2*

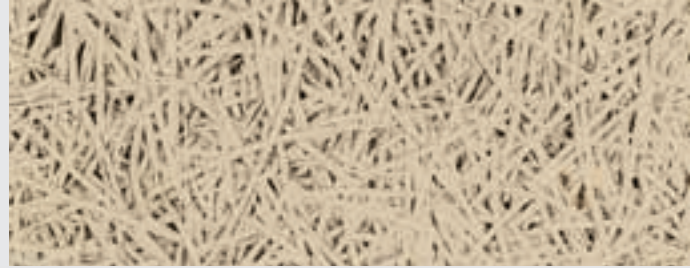

HERADESIGN® *superfine A2*

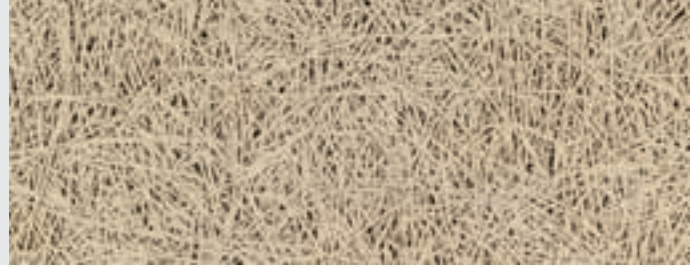

Product range for HERADESIGN® *fine A2*, *superfine A2*

| | | |
|---|---------------------|---------------|
| Nominal size mm (further sizes on request) | | 600 x 600 mm |
| | | 1200 x 600 mm |
| Thickness | 1-lagig | 15 mm |
| | | 25 mm |
| Weight kg/m ² | <i>fine A2</i> | 13.0 (15 mm) |
| | | 19.0 (25 mm) |
| | <i>superfine A2</i> | 12.0 (15 mm) |
| | | 18.0 (25 mm) |
| ABZ General Building Approval: Z-23.15-1562 | | |
| Reaction to fire according to EN 13501-1: A2-s1, d0 | | |
| Special formats on request. Length of max. 2400 mm | | |

Sound absorption values

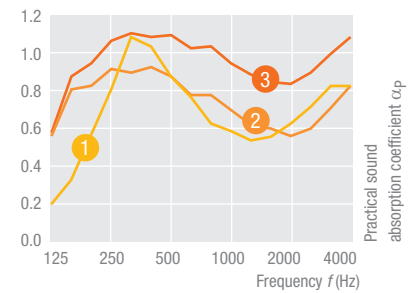

- 1 HERADESIGN® *fine A2*, 25 mm
 α_w up to 0.65 NRC = up to 0.70
- 2 HERADESIGN® *fine A2*, 15 mm
 α_w up to 0.70 NRC = up to 0.75
- 3 HERADESIGN® *superfine*, 25 mm
 α_w up to 0.95 NRC = up to 1.00

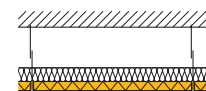

suspended with acoustic lining



Product Range *plus*

 HERADESIGN® *plus*

Composite product consisting of a magnesite bonded wood wool acoustic panel and a mineral wool absorber

- Excellent sound absorption values
- Trickle protection
- Easier and faster installation

Wood wool acoustic panel. Available in the following surface textures:

 HERADESIGN® *macro plus*

 HERADESIGN® *fine plus*

 HERADESIGN® *superfine plus*

 HERADESIGN® *micro plus*

 HERADESIGN® *plano plus*

Product Range *plus*

| | | |
|---|-----------------------|-----------------------|
| Nominal size mm | | 1200 x 600 mm |
| Thickness | 2-layers | 40 mm (15/25 mm) |
| | | 50 mm (25/25 mm) |
| | | 55 mm (15/40 mm) |
| | | 65 mm (25/40 mm) |
| Edge design | | AK-01 plus (15/25 mm) |
| | | AK-01 plus (25/25 mm) |
| | | SK-04 plus (15/40 mm) |
| | | SK-04 plus (25/40 mm) |
| Weight kg/m ² | <i>macro plus</i> | 14.7 (25/25 mm) |
| | | 16.0 (25/40 mm) |
| | <i>fine plus</i> | 10.5 (15/25 mm) |
| | | 14.7 (25/25 mm) |
| | | 11.8 (15/40 mm) |
| | | 16.0 (25/40 mm) |
| | <i>superfine plus</i> | 10.1 (15/25 mm) |
| | | 13.6 (25/25 mm) |
| | | 11.4 (15/40 mm) |
| | | 14.9 (25/40 mm) |
| | <i>micro plus</i> | 17.3 (25/25 mm) |
| | | 18.6 (25/40 mm) |
| ABZ General Building Approval: Z-23.15-1562 | | |
| Reaction to fire according to EN 13501-1: B-s1, d0 <i>superfine plus</i> and <i>fine plus</i> also available in A2 quality | | |

Sound absorption values

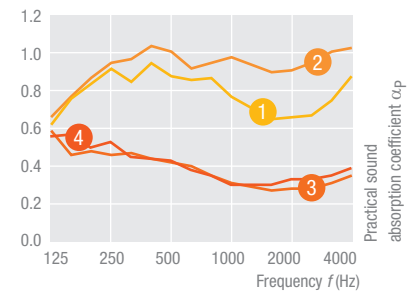

- 1 HERADESIGN® *fine plus*
 α_w up to 0.85 NRC = up to 0.85
- 2 HERADESIGN® *superfine plus*
 α_w up to 0.95 NRC = up to 0.95
- 3 HERADESIGN® *micro plus*
 α_w up to 0.35 NRC = up to 0.35
- 4 HERADESIGN® *plano plus*
 α_w up to 0.35 NRC = up to 0.40

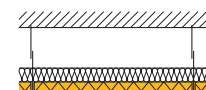

suspended with acoustic lining

Edge design



AK-01



SK-04



ASF

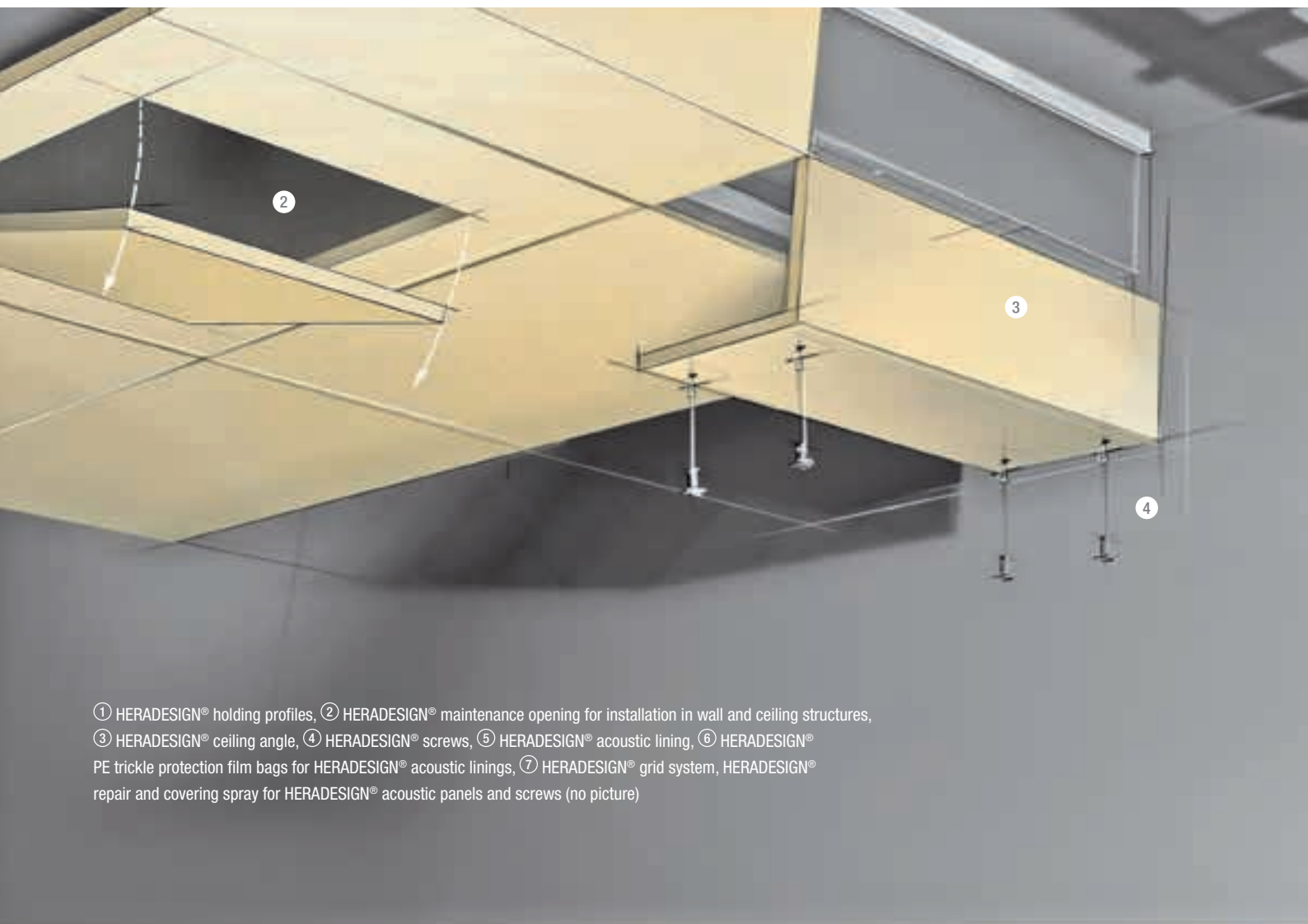

① HERADESIGN® holding profiles, ② HERADESIGN® maintenance opening for installation in wall and ceiling structures,
 ③ HERADESIGN® ceiling angle, ④ HERADESIGN® screws, ⑤ HERADESIGN® acoustic lining, ⑥ HERADESIGN®
 PE trickle protection film bags for HERADESIGN® acoustic linings, ⑦ HERADESIGN® grid system, HERADESIGN®
 repair and covering spray for HERADESIGN® acoustic panels and screws (no picture)

We'll find the right acoustic solution for your well-being

Take advantage of the many applications of **HERADESIGN®** products and their outstanding mounting systems
 Whether it's the **HERADESIGN®** ceiling or wall designs, or the standard or special installation systems with
 elaborate system accessories.





Baffles – when ceilings are to remain visible

There are rooms that require acoustic solutions, but where the entire ceiling cannot be lined. This may be due to ceilings with concrete cores or because of technical installations running along the ceiling, or simply for architectural reasons. **HERADESIGN®** baffles are ideal for all these cases! Baffles are single 2 (**HERADESIGN® Baffle *basic***) or 3-layer (**HERADESIGN® Baffle *aluDesign***) acoustic units with wood wool acoustic cover layers on both sides. In contrast to the 2-layer model, the 3-layer baffle has an additional mineral wool core. The combination of wood wool and mineral wool yields outstanding absorption values in a wide frequency range. Thanks to their special shape, baffles create unique design options, which is why they are also very popular as design elements in schools or public buildings.

- Specific acoustic solutions for areas where ceilings are to remain visible
- High sound absorption properties
- Different sizes, surfaces and frame designs



① ② ③ Rhein-Waal University, Kleve, Germany, HERADESIGN® *superfine*

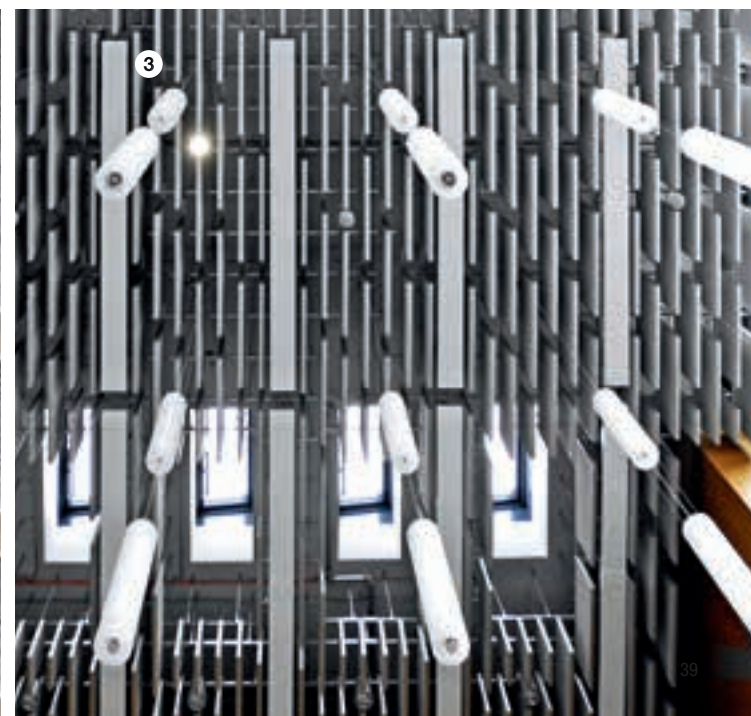

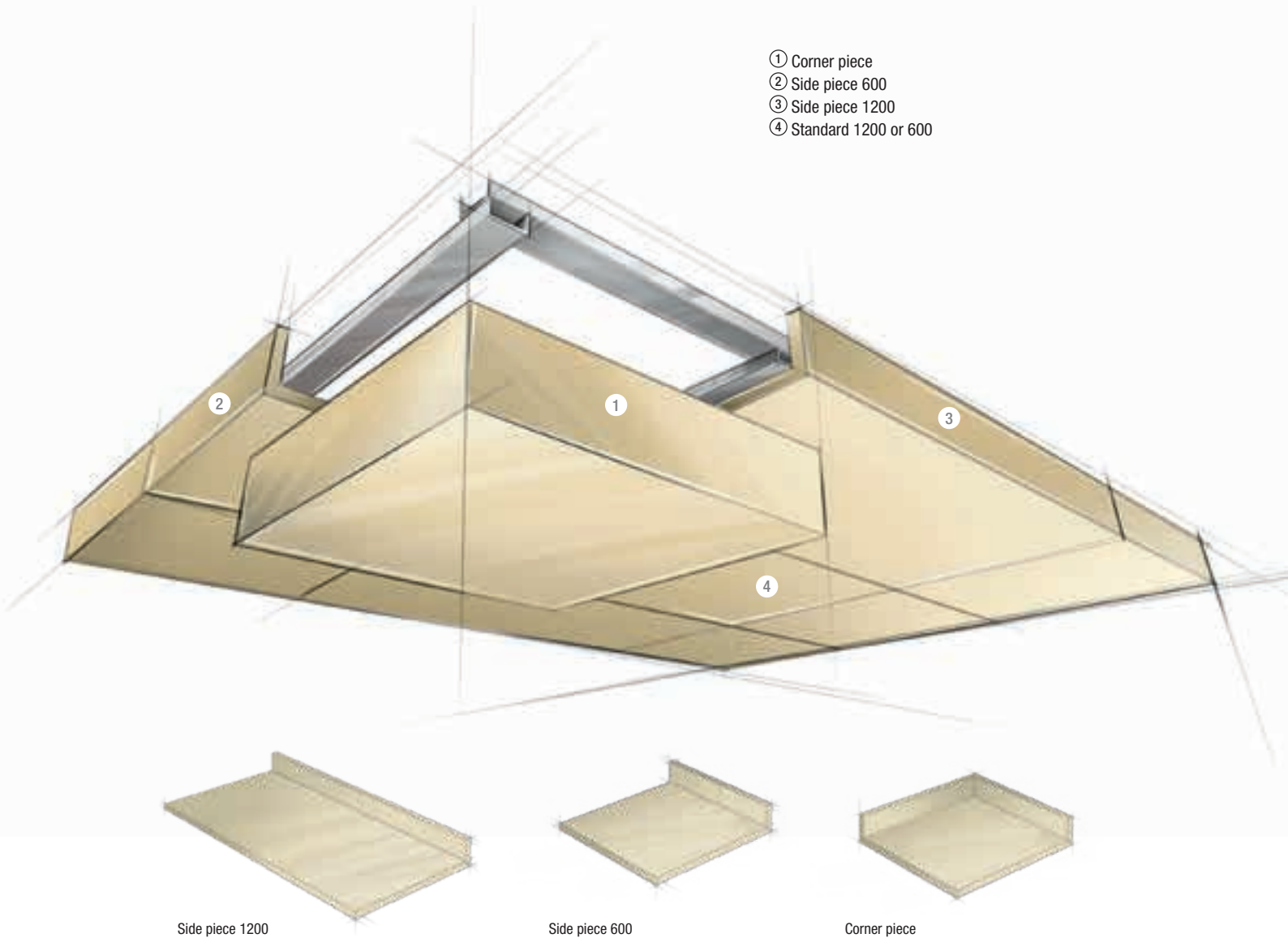

Ceiling rafts

HERADESIGN® ceiling rafts have been designed especially for large rooms with individual communication islands. They provide individual optimisation of acoustics, which considerably improves speech intelligibility and concentration. However, ceiling rafts are more than simply acoustic solutions: the unique wood wool appearance of the surface texture also makes visually appealing and unusual design options possible.

HERADESIGN® ceiling rafts are also highly recommended as an additional sound absorption measure. Thanks to their fast installation, the acoustics and ambience in the room can be improved without the need to re-install or exchange the whole ceiling. Furthermore, ceiling rafts enable segmentation of areas in the same room without having to erect dividing walls or partitions. This saves on costs and space.

- Individual optimisation of acoustics
- Design possibilities
- Flexible application
- Also available in kit form

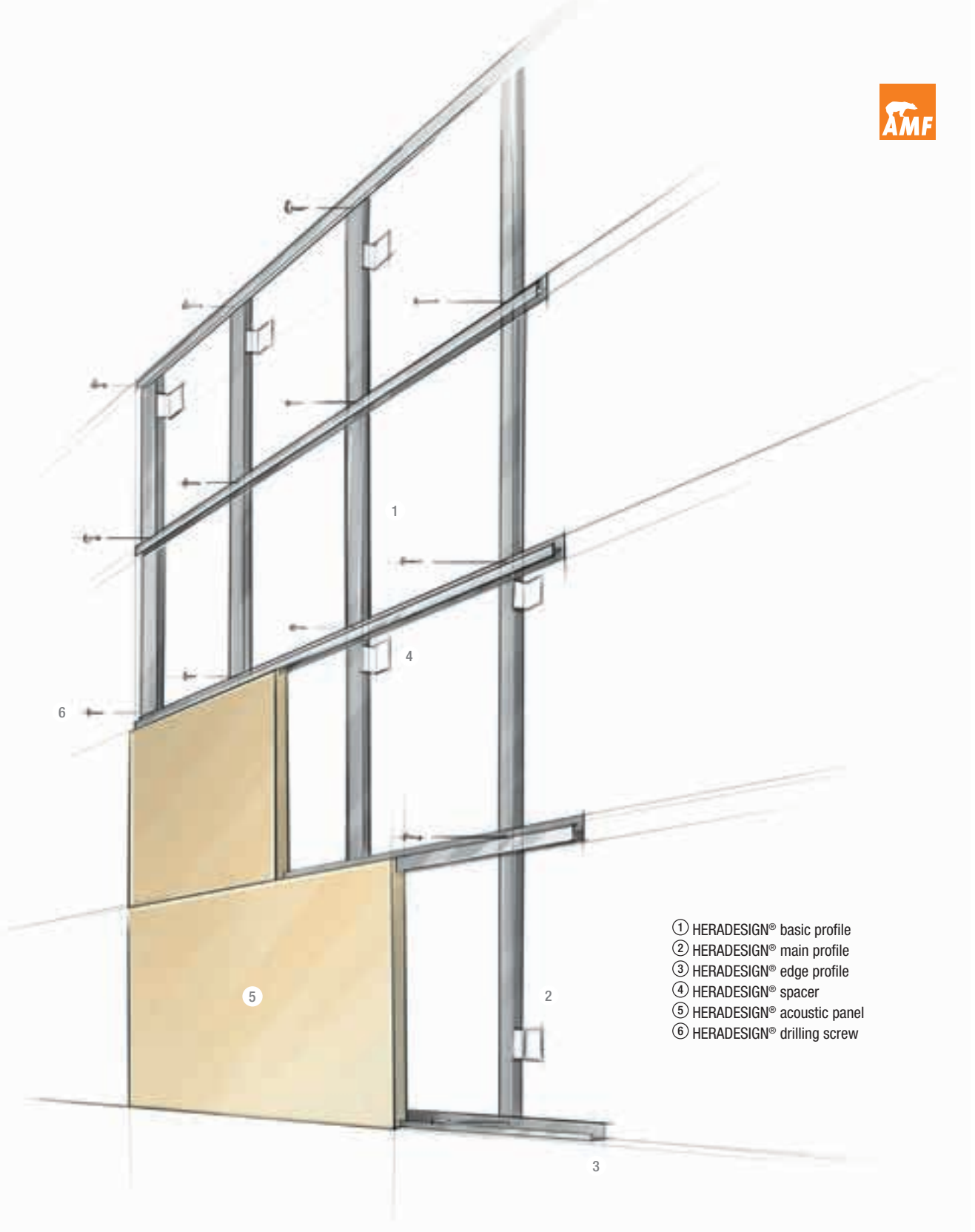

- ① HERADESIGN® basic profile
- ② HERADESIGN® main profile
- ③ HERADESIGN® edge profile
- ④ HERADESIGN® spacer
- ⑤ HERADESIGN® acoustic panel
- ⑥ HERADESIGN® drilling screw

Holding profiles

It is not only the ceiling that makes a room perfect; you can give a room a special effect by mounting an acoustic wall solution. Take advantage of the many applications of HERADESIGN® products and their respective mounting systems.

- Easy and quick installation thanks to coordinated system components
- For mounting on walls and ceilings
- High stability due to continuous main and edge profiles
- Aluminium holding profiles for high-grade concealed systems



Installation

The impressive appearance of a HERADESIGN® acoustic solution always depends on two factors: the acoustic panel itself and good workmanship. Knowing exactly what to do results in a quick, easy and clean installation of the panels to the building owner's satisfaction.



Installation types

- Screw mounting onto wood laths
- Screw mounting onto CD sections
- Suspended ceiling with visible T-sections
- Suspended ceiling with concealed T-sections
- Wall mounting with HERADESIGN® holding profiles

System **B** Screw mounting onto wooden laths

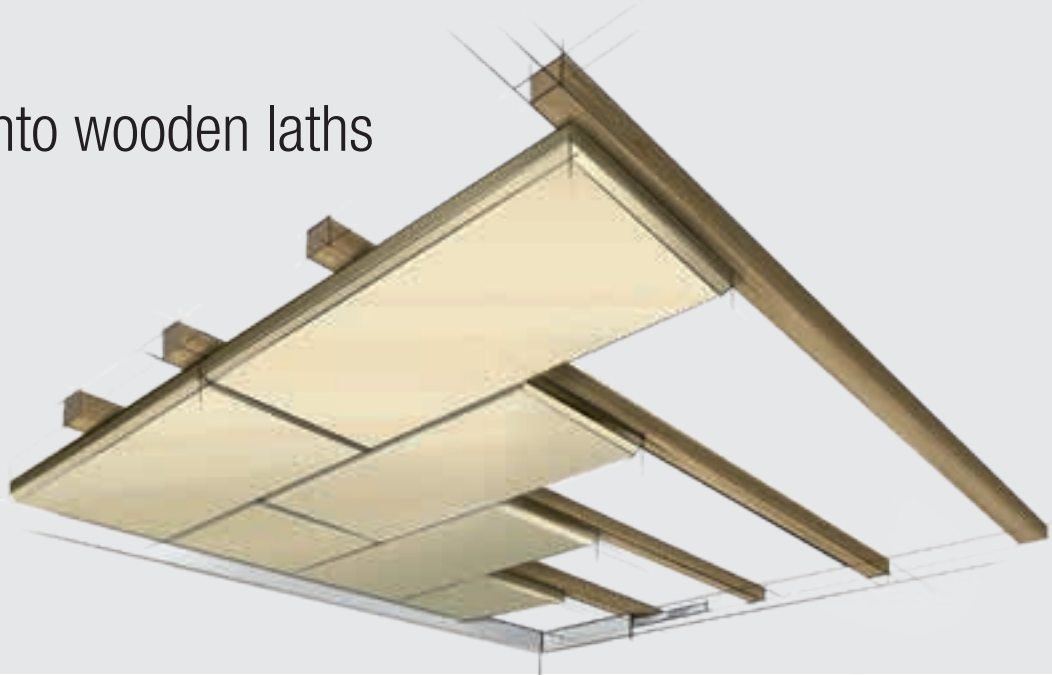

Design that is impact resistant
with 25 and 35 mm thick panels



Extensive detailed information on system structures, certificates and assembly can be found at www.heradesign.com and in the HERADESIGN® Installation Guide.

System **B**

Screw mounting onto CD profiles

Design that is impact resistant
with 25 and 35 mm thick panels

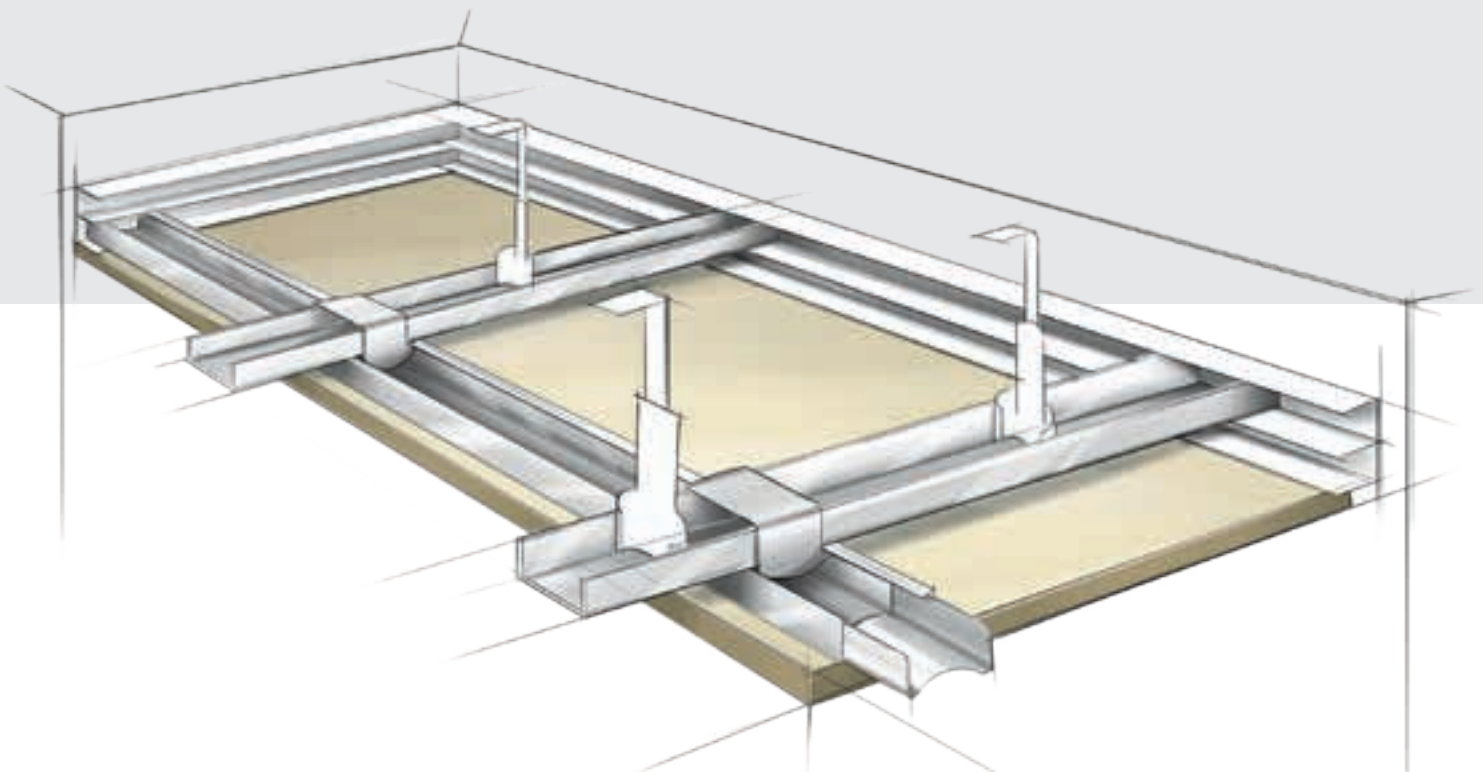

Technical notes (for both assembly types):

Impact resistant design for ceilings and walls according to DIN 18023/Part 3 or EN 13964, Annex D

At least 3 screws per panel width and support

Max. distance of screws: < 315 mm

Centre distance: cross profiles/main profiles 600/625 mm
main profiles/basic profiles 900 mm (vernier hanger)

Size of cross and main profiles: > 60 x 30 mm

Size of profiles: 60/27/0.6 mm

Recommended panel thickness: 25 mm for ceilings, 35 mm for walls (except: Product Range A2)

HERADESIGN® *plus* products are available with AK-01 edge design.

System **C**

Suspended ceiling with exposed T-profiles

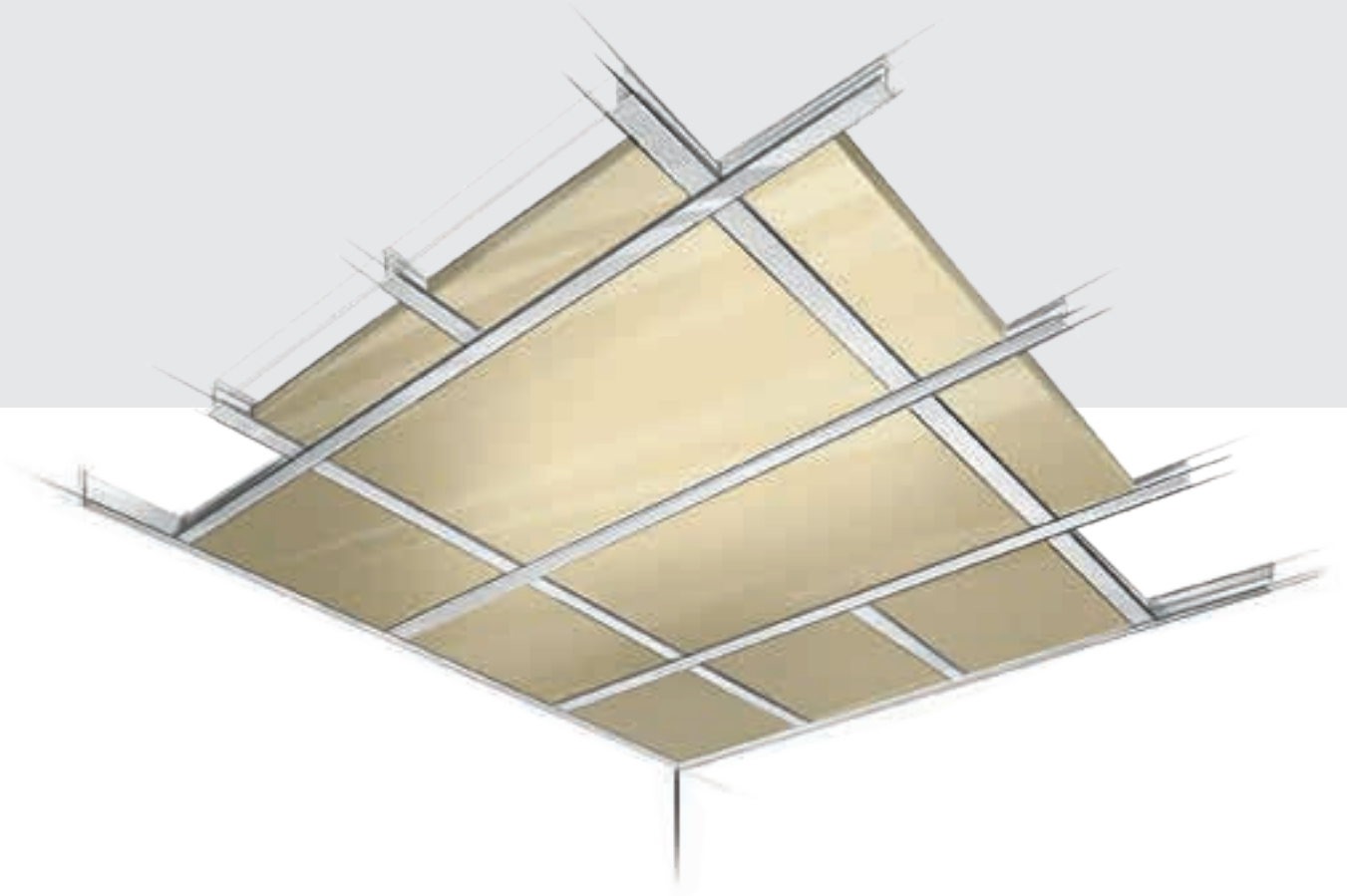

Technical notes:

15 mm thick products are only available as standard in the sizes 600/600 or 625/625 mm.

The panel dimensions are smaller than the grid dimensions.

The SK-04 edge design, thicknesses of 25 and 35 mm, is undercut on the back.

Different EI 30 or F 30 constructions are possible and have been tested.

Take into consideration the minimum suspension heights (see **HERADESIGN**[®] Installation Guide).

HERADESIGN[®] *plus* products are available with SK-04 edge design.

Knauf AMF is not a kit provider in terms of DIN-EN 13964.

System **A** Suspended ceiling with concealed T-profiles

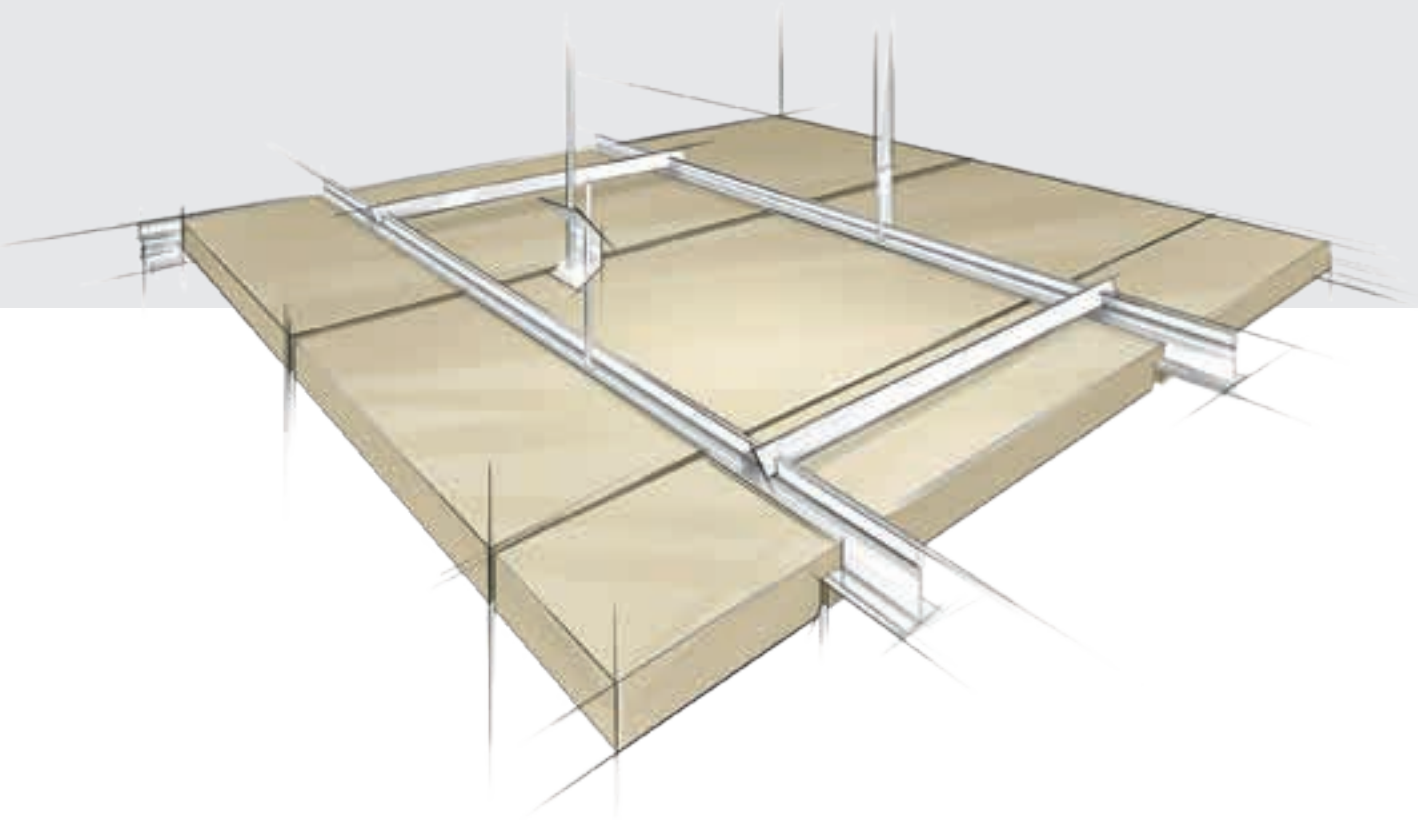

Technical notes:

Spacers must be used for cross bracing of the system – max. distance 1200 mm.

Panel dimensions are only available for grid dimensions 600.

The VK-09 edge design is available in the thicknesses of 25 and 35 mm.

Special formats only on request – max. length 1800 mm.

The VK-10 and VK-10/5 edge designs are only available in the thickness of 35 mm.



Extensive detailed information on system structures, certificates and assembly can be found at www.heradesign.com and in the HERADESIGN® Installation Guide.



AMF VENTATEC® – grid systems and substructures from Knauf AMF

Acoustic ceiling tiles, substructure and grid from one source guarantee quality, system safety, time savings and cost benefits.

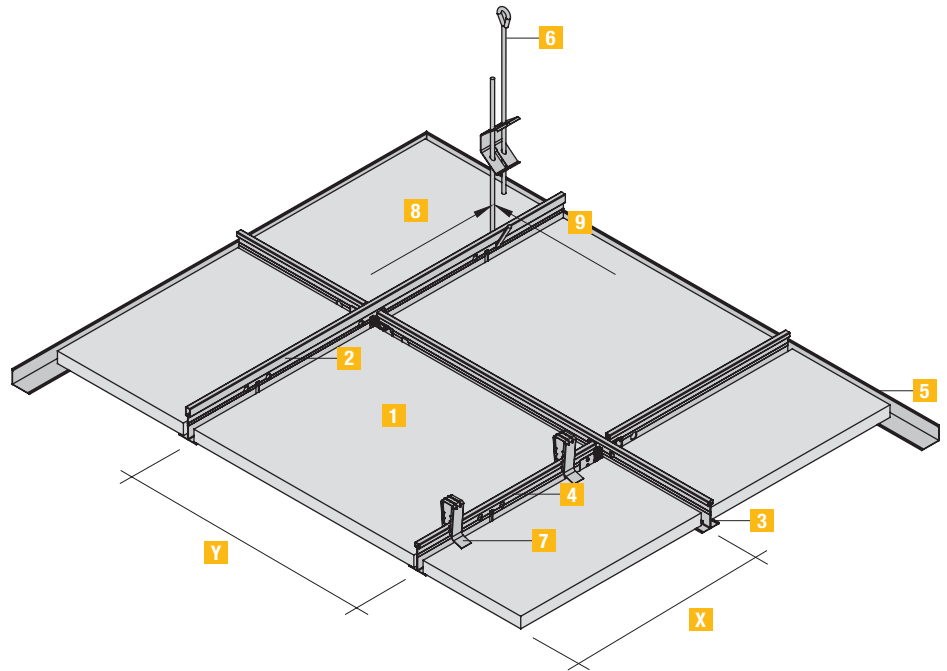

System **C**
Exposed system, tiles demountable

| Required materials for System C (per m ²) | | | | | | |
|--|---|---------|-----------|-----------|------------|------------|
| X Y | Module size in mm | | 600 x 600 | 625 x 625 | 600 x 1200 | 625 x 1250 |
| 1 | AMF-mineral tiles | piece | 2,78 | 2,56 | 1,39 | 1,28 |
| 2 | T-main profile T24/38-3600 or 3750 | lin. m. | 0,84 | 0,80 | 0,84 | 0,80 |
| 3 | T-cross profile T24/33 -1200 or 1250 | lin. m. | 1,67 | 1,60 | 1,67 | 1,60 |
| 4 | T-cross profile T24/33 -600 or 625 | lin. m. | 0,84 | 0,80 | – | – |
| 5 | RWL perimeter trim | lin. m. | 0,60 | 0,60 | 0,60 | 0,60 |
| 6 | SoS quick hanger with upper loop or alternative | piece | 0,67 | 0,67 | 0,67 | 0,67 |
| 7 | Spring clip DFK (optional) | piece | 5,56 | 5,12 | 2,78 | 2,56 |
| 8 | Hanger centres | m | 1,25 | 1,20 | 1,25 | 1,20 |
| 9 | Main profile centres | m | 1,20 | 1,25 | 1,20 | 1,25 |

| Grid systems for System C (per m ²) | | |
|--|----------------------------------|------------------|
| AMF VENTATEC® | VENTATEC® Performance T24 | Joggled version |
| | | Butt-cut version |
| | VENTATEC® Performance - HIGH T24 | Joggled version |
| | | Butt-cut version |
| VENTATEC® Performance T15 | Butt-cut version | |



Would you like to find out more about AMF VENTATEC®?
If you have any questions regarding the application and choice of systems, your local representative is available to advise you! Further information about AMF VENTATEC® can also be found at: www.knaufamf.com

For concealed T-profile - edge VK-10

(see page 47)

- Demountable system with concealed T-profiles
- The system is cross-braced using spacer bars above every second tile. Therefore, every second tile is immediately demountable.
- To ensure problem-free installation of the tiles, the minimum suspension height for installations using suspension wire and eyes is 14 cm. For flat hangers or a suspension with sliding components, a minimum of 19 cm is required. For mineral wool overlays, the minimum suspension height should be increased by the thickness of the mineral wool.

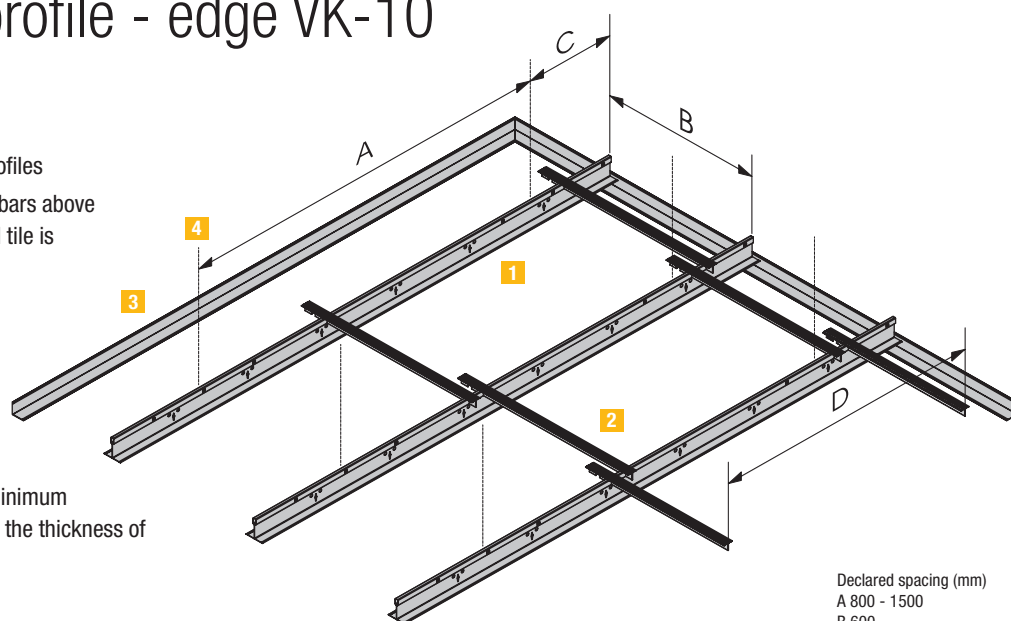

Declared spacing (mm)
 A 800 - 1500
 B 600
 C max. 400
 D max 1250

System **A** Concealed System, tiles demountable

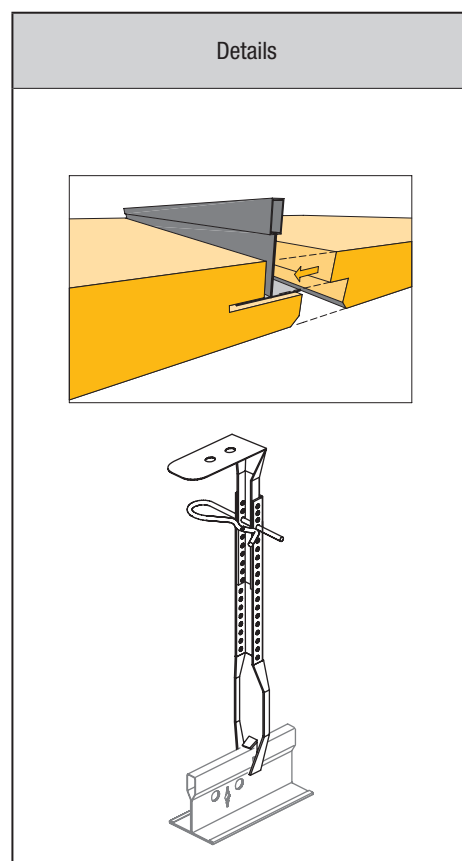

| Required material for System A (per m ² ceiling area) ¹⁾ | | | | |
|---|-------------|---------------|------------------|-------------------|
| No. | Description | Article No. | Module 600 x 600 | Module 600 x 1200 |
| 1 | Main runner | DX35 XH 370 W | 1.70 m | 1.70 m |
| 2 | Spacer bar | | 0.70 m | 0.70 m |
| 3 | Wall angle | | 0.40 m | 0.40 m |
| 4 | Hanger | | 1.35 pieces | 1.35 pieces |

¹⁾ All figures are approximate without allowing for waste

| Loading table – maximum permissible weight in kg (per m ² ceiling area) | | |
|--|------------------|-------------------|
| Main runner centres | 600 mm | 600 mm |
| Hanger centres A (mm) | Module 600 x 600 | Module 600 x 1200 |
| 800 | 30.0 | 30.0 |
| 1000 | 30.0 | 30.0 |
| 1200 | 22.6 | 22.9 |

Note:
 The load per m² must be distributed evenly (no extra point loads permitted).
 The deflection in accordance with class 1 (L/500) of EN 13964 is according to the load, assuming the substructure is installed as shown in the drawings.

For other ceiling structures, loads or hanger centres, please contact Knauf AMF.

Wall mounting with HERADESIGN® holding profiles

High-grade grid mounting system with concealed sections



Impact resistant design
with 35 mm thick panels



Technical notes:

Main and edge profiles are available in the lengths 3000 and 1500 mm.

Mounting on wood laths or as a high-grade grid mounting system with concealed aluminium sections possible.

Panel dimensions only available in the sizes 1200/600 and 600/600 mm.

The SY-02 edge design is available in the thicknesses of 25 and 35 mm.

Not suitable for indoor swimming pools.

Follow the installation instructions!

Concealed installation with HERADESIGN® holding profiles is also an alternative for ceiling applications.



Processing information and installation instructions

HERADESIGN® acoustic panels are delivered to the building site carefully packed and quality tested. However, a high-quality ceiling or ceiling design also depends on exact processing and suitable working environment. Only careful work and high product quality standards ensure an excellent result.



Material and humidity

Due to the organic nature of wood as a component in HERADESIGN® panels, minor deviations in size cannot be ruled out. Particularly in strongly fluctuating humidity, the panels may shrink or swell to a small degree.

Production tolerances:

For nominal sizes (length/width/thickness): ± 1 mm,

For lengths over 1250 mm: length ± 2 mm;

width/thickness ± 1 mm

Final shrinkage in a standard climate of 23° C and 50% rel. humidity:

Change of length: max. $\pm 1\%$

Change of width: max. $\pm 3\%$

Colour and texture

Due to the organic nature of the raw materials magnesite and wood, differences in colour and texture may occur. The direction of installation (ideal grain direction), marked by an arrow on the back of the panel, must be observed for square panels.

Compared to standard products, A2 products have a more random surface texture. Acoustic panels with the fibre textures *macro*, *superfine*, *fine*, *fine A2* and *superfine A2* can also be painted many times without losing their outstanding sound absorption properties.

Colour quality

Interior emulsion paint is used for colouring HERADESIGN® acoustic panels in standard white, while silicate paints based on potassium silicate with an organic binding agent additive are used for colouring HERADESIGN® acoustic panels in natural tones, pastel colours or solid colours. For applications with constant relative humidity between 80% and 90% the paint should be used with a BFA additive.

For sheltered external applications, exterior paint must be used.

Storage and installation conditions

The installation of HERADESIGN® acoustic panels is part of dry work and interior decorating and may only be carried out under controlled humidity and temperature conditions. All dust-producing construction measures must be completed before starting installation. It must no longer be possible for moisture or rain water to penetrate. Furthermore, before starting installation work, a closed building envelope has to be ensured and all screed work and internal plastering must have been completed at least 14 days previously. Only install panels in rooms where the following conditions are assured:

For heated or air-conditioned rooms: maximum relative humidity 75%, temperature at least + 7° C.

For unheated rooms: maximum relative humidity 85%, temperature at least + 5° C.

Conditioning and acclimatisation: The panels need to be stored with the packaging removed for at least three days in the room where they are to be installed, and under the same climatic conditions as when the room will be in use (including where heating and air conditioning are used).

The maximum installation moisture of the HERADESIGN® acoustic panels must not exceed 15% by weight.

Application limits

HERADESIGN® acoustic panels are suitable for applications up to a constant relative humidity of 90%.



Extensive detailed information on system structures, certificates and assembly can be found at www.heradesign.com and in the HERADESIGN® Installation Guide.









System edges

The HERADESIGN® acoustic panels can be supplied with different edge designs to correspond to the architectural concept and the planned installation type. This way, HERADESIGN® acoustic panels can be used for almost all common suspension systems and installation methods.

| Abbreviation | Design | Description of the edge | HERADESIGN® | | | | | | | | | | | | Recommended section width ⁶⁾ | Comments | Grid dimensions ²⁾ | Panel dimensions | | |
|---|--------|---|---------------------------------|----|------------------|----|-----------------------|----|-------------------|----|---------------------------------|----|---------------------|----|---|----------|-------------------------------|------------------|--------------------------------------|--------------------------------------|
| | | | HERADESIGN® macro ⁷⁾ | | HERADESIGN® fine | | HERADESIGN® superfine | | HERADESIGN® micro | | HERADESIGN® plano ⁸⁾ | | HERADESIGN® fine A2 | | | | | | HERADESIGN® superfine A2 | |
| System B | | | 25 | 15 | 25 | 35 | 15 | 25 | 35 | 25 | 35 | 25 | 15 | 25 | 15 | 25 | mm | L/W (mm) | L/W (mm) | |
| System edges: screw mounting | | | | | | | | | | | | | | | | | | | | |
| GK | | straight edge on all sides | • | • | • | • | • | • | • | • | • | • | • | • | • | • | 60 | 1) 3) | 600/600 625/625 1200/600 1250/625 | 600/600 625/625 1200/600 1250/625 |
| AK-00 | | bevelled on long sides, 5 mm bevel, straight edge on the face side | • | • | • | • | • | • | • | • | • | • | • | • | • | • | 60 | 3) | 600/600 625/625 1200/600 1250/625 | 600/600 625/625 1200/600 1250/625 |
| AK-01 | | edge bevelled on all sides, 5 mm bevel | • | • | • | • | • | • | • | • | • | • | • | • | • | • | 60 | 3) | 600/600 625/625 1200/600 1250/625 | 600/600 625/625 1200/600 1250/625 |
| AK-02 /5 | | straight edge with shiplap on all sides, 5 mm joint width | • | – | • | • | – | • | • | • | • | – | – | • | – | • | 60 | 3) | 600/600 625/625 1200/600 1250/625 | 600/600 625/625 1200/600 1250/625 |
| AK-02 /10 | | straight edge with shiplap on all sides, 10 mm joint width | • | – | • | • | – | • | • | • | • | – | – | • | – | • | 60 | 3) | 600/600 625/625 1200/600 1250/625 | 600/600 625/625 1200/600 1250/625 |
| AK-02 /20 | | straight edge with shiplap on all sides, 20 mm joint width | • | – | • | • | – | • | • | • | • | – | – | • | – | • | 60 | 3) | 600/600 625/625 1200/600 1250/625 | 600/600 625/625 1200/600 1250/625 |
| AK-03 | | shiplap on all sides with bevelled edge, 5 mm bevel, 20 mm joint width | • | – | • | • | – | • | • | • | • | – | – | • | – | • | 60 | 3) | 600/600 625/625 1200/600 1250/625 | 600/600 625/625 1200/600 1250/625 |
| System edges: HERADESIGN® Exposed Grid System 24/38, insertion installation | | | | | | | | | | | | | | | | | | | | |
| System C | | | 25 | 15 | 25 | 35 | 15 | 25 | 35 | 25 | 35 | 25 | 15 | 25 | 15 | 25 | mm | L/W (mm) | L/W (mm) | |
| SK-04 | | straight edge on all sides | • | • | • | • | • | • | • | • | • | • | • | • | • | • | 24 | 2) 4) | 600/600 625/625 1200/600 1250/625 | 594/594 619/619 1194/594 1244/619 |
| SK-05 | | straight edge with shiplap on all sides | • | – | • | • | – | • | • | • | • | – | – | • | – | • | 24 | 2) 4) | 600/600 625/625 1200/600 1250/625 | 594/594 619/619 1194/594 1244/619 |
| SK-06 | | shiplap on all sides with bevelled edge, 5 mm bevel | • | – | • | • | – | • | • | • | • | – | – | • | – | • | 24 | 2) 4) | 600/600 625/625 1200/600 1250/625 | 594/594 619/619 1194/594 1244/619 |
| System edges: HERADESIGN® Concealed Grid System 35/38, slide-in installation | | | | | | | | | | | | | | | | | | | | |
| System A | | | 25 | 15 | 25 | 35 | 15 | 25 | 35 | 25 | 35 | 25 | 15 | 25 | 15 | 25 | mm | L/W (mm) | L/W (mm) | |
| VK-09 | | grooved and bevelled on all sides, 5 mm bevel Note: The system can't be disassembled! | • | – | • | • | – | • | • | • | • | • | • | • | • | • | 35 | 3) 5) | 600/600 1200/600 | 600/600 1200/600 |
| VK-10 | | grooved on long sides and bevelled on all sides, 5 mm bevel Note: The system can be disassembled! | – | – | – | • | – | – | • | – | • | – | – | – | – | – | 35 | 2) 3) 5) | 600/600 1200/600 | 600/615 1200/615 |
| VK-10 /5 | | grooved on long sides and straight edge on all sides with 5 mm bevel all round Note: The system can be disassembled! | – | – | – | • | – | – | • | – | • | – | – | – | – | – | 35 | 2) 3) 5) | 600/600 1200/600 | 600/615 1200/615 |
| System edges: special installation (special sections) | | | | | | | | | | | | | | | | | | | | |
| System S | | | 25 | 15 | 25 | 35 | 15 | 25 | 35 | 25 | 35 | 25 | 15 | 25 | 15 | 25 | mm | L/W (mm) | L/W (mm) | |
| SY-02 | | for HERADESIGN® holding profiles, grooved on long sides and bevelled on all sides, 5 mm bevel | • | – | • | • | – | • | • | • | • | • | – | • | – | • | 35 | 3) | 600 625 | 600/600 625/625 1200/600 1250/625 |
| SY-03 | | for concealed top hat sections straight edge on all sides with 5 mm bevel all round | • | – | • | • | – | • | • | • | • | – | – | • | – | • | 12 | 2) 4) | 600/600 625/625 1200/600 1250/600 | 600/595 625/620 1200/595 1250/620 |
| SY-08 | | for visible top hat sections straight edges on long sides, bevelled edges on the face side | • | – | • | • | – | • | • | • | • | – | – | • | – | • | 20 | 2) 4) | 620 645 | 600/595 625/620 1200/595 1250/620 |

- 1) The straight edge is not an exposed edge: only produced at the request of the customer (max. panel width 600 mm).
- 2) The billing dimensions or the ordering dimensions are always the grid dimensions.
- 3) Installation pattern in cross joints requires careful installation, because four panel edges have to meet at one point.
- 4) The panel dimensions are smaller than the grid dimensions.
- 5) Special formats only on request. For lengths of over 1800 mm, please contact customer services.
- 6) Products of 15 mm thickness are only available in the sizes 600/600 or 625/625.
- 7) Panel width max. 600 mm.
- 8) For screw mounting, the section width also applies to the wooden substructure.
- 9) For HERADESIGN® plano, the bevel at the AK-01, SK-06, VK-09, SY-02 edges is only 3 mm.



Customer
quotes

“We are designing with HERADESIGN® acoustic solutions,
because good room acoustics have to be seen!”

Anton Mang / Wollmann & Mang, Munich, Germany

“I use HERADESIGN® acoustic panels in my projects all the time.

They have a special surface effect combine ecology,
sound absorption and design in a unique way.”

Eberhard Lämmle, independent architect, Vaihingen, Germany

SOMAA. likes planning with HERADESIGN® products, because they can be used in a variety of innovative ways. “Our craftsmen like working with HERADESIGN® products, because the material is user-friendly and simple. Our building owners appreciate HERADESIGN®, because the product is both ecological and economical at the same time.”

Hadi A. Tandawardaja, architect, SOMAA. – Society for Architecture and Design



Further references and interesting projects can
also be found in the HERADESIGN® Lookbook.





Service, Support, Logistics – Centre of expertise in Europe and on-site sales networks worldwide



Knauf AMF GmbH & Co. KG
Elsenthal 15, 94481 Grafenau
Germany

Tel.: +49 8552 422-0

Fax: +49 8552 422-32

info@knaufamf.com

www.knaufamf.com

The acoustic ceiling specialist Knauf AMF, with its global sales and service network, offers on-site, solution orientated and timely advice for architects, specialist contractors, distributors and developers.

With us, you are always a ceiling solution ahead!

No responsibility or liability is accepted for the accuracy of the information provided.
Subject to change without prior notice.

08/2018

Knauf AMF Deckensysteme GmbH
9702 Ferndorf 29
Austria
Tel.: +43 4245 2001-0
office@heradesign.com
www.heradesign.com